

MESSTEC Power Converter GmbH			
Operating Manual TEC-Controller 3A			
Document: 101001200M	Revision: 1.0	Date: 19.09.2022	Page 1/71



TEC-controller 3A



Warning!
Risk of exposure of hazardous laser radiation
in combination with laser light emitting devices!

Revision	1.0					
Created		Approved		Released		Form
19.09.2022	OWa	19.09.2022	SEn	19.09.2022	KS	
Distribution:				File:		



MESSTEC Power Converter GmbH			
Operating Manual TEC-Controller 3A			
Document: 101001200M	Revision: 1.0	Date: 19.09.2022	Page 2/71

Table of Content

1.	Introduction	5
2.	First steps – Getting started	7
3.	TEC-Controller	8
4.	The Setup – General Instructions	11
4.1.	Mechanical Setup	11
4.2.	Electrical Setup for Control and Monitoring	13
5.	Temperature sensor	20
5.1.	Platinum Sensor	20
5.2.	Nickel Sensor	21
5.3.	NTC	22
5.4.	Silicon Sensor (KTY11-5)	23
5.5.	Arbitrary Sensor	24
5.6.	Sensor Current	26
6.	Indicator elements	27
6.1.	Indication of operating states	27
6.1.1.	Indicator LEDs	27
6.1.2.	Booting sequence	28
6.1.3.	Safe-State during configuration of digital Inputs/Outputs	29
6.2.	Indication of serial data transfer	29
6.3.	Monitoring of supply voltages	30
7.	Wiring and connectors	31
7.1.	Hookup groups	31
7.2.	Connectors and signals	32
7.2.1.	Supply Voltage X5	34
7.2.2.	Peltier element X6	35
7.2.3.	Control Signals Digital X2	36
7.2.4.	Control Signals Analog X1	39

MESSTEC Power Converter GmbH			
Operating Manual TEC-Controller 3A			
Document: 101001200M	Revision: 1.0	Date: 19.09.2022	Page 3/71

- 7.2.5. **Wiring examples for the analog input CA-SETPOINT**41
 - 7.2.5.1. **Internal Potentiometer**41
 - 7.2.5.2. **External Potentiometer with reference voltage**.....41
 - 7.2.5.3. **Voltage Controller**42
- 7.2.6. **Temperature Sensor X4**.....43
- 7.2.7. **USB/RS232**45
- 8. **Configuration in Detail**47
 - 8.1. **HW Setpoint**.....47
 - 8.1.1. **HW-Setpoint Boundary Mode: Clipping**48
 - 8.1.2. **HW-Setpoint Boundary Mode: Slope Transformation**.....49
 - 8.2. **Digital Inputs and Outputs**.....51
 - 8.2.1. **Inputs**.....51
 - 8.2.2. **Outputs**.....52
- 9. **Error states**53
 - 9.1. **SENSOR Error**53
 - 9.2. **OVERTEMPERATURE Error**54
 - 9.3. **SHORTCIRCUIT Error**54
- 10. **PC Software: TEC Control**.....55
 - 10.1. **Main menu**.....55
 - 10.2. **Configuration**59
 - 10.2.1. **Temperature limits**.....60
 - 10.2.2. **Current limit**61
 - 10.2.3. **Voltage limit**61
 - 10.2.4. **Boundary Mode**62
 - 10.2.5. **Sensor selection**.....62
 - 10.2.6. **Control parameter**.....63
 - 10.2.7. **Enable Mode**64
 - 10.2.8. **Setpoint Mode**.....64
 - 10.2.9. **Colours**.....64
 - 10.2.10. **Language**65
 - 10.2.11. **IO Configuration**65
 - 10.3. **USB Driver**.....68
- 11. **Drawings**69

MESSTEC Power Converter GmbH			
Operating Manual TEC-Controller 3A			
Document: 101001200M	Revision: 1.0	Date: 19.09.2022	Page 4/71

11.1. Mechanical Drawings	69
11.2. Mounting Positions.....	70
12. TEC-Controller family	71

MESSTEC Power Converter GmbH			
Operating Manual TEC-Controller 3A			
Document: 101001200M	Revision: 1.0	Date: 19.09.2022	Page 5/71

1. Introduction

The TEC-Controller (**T**hermo **E**lectric **C**ooler) is a temperature controller with high accuracy. This controller is combined with appropriate power electronics of high efficiency to feed Peltier Elements.

TEC-Controllers up to 50V from MPC are available in 4 output current ranges:

- up to 3A output current
- up to 6A output current
- up to 12A output current
- up to 24A output current

Note: In this document only the TEC-Controller up to 3A is covered.

The TEC-Controller 3A is a newly developed, small module with very high power density due to state of the art power stages in GaN technology.

TEC-Controllers from MPC can be operated in various modes:

- Hardware only
- Software only
- combination of hardware and software control

TEC-Controllers from MPC are standalone. Fig. 1 shows a minimal system.

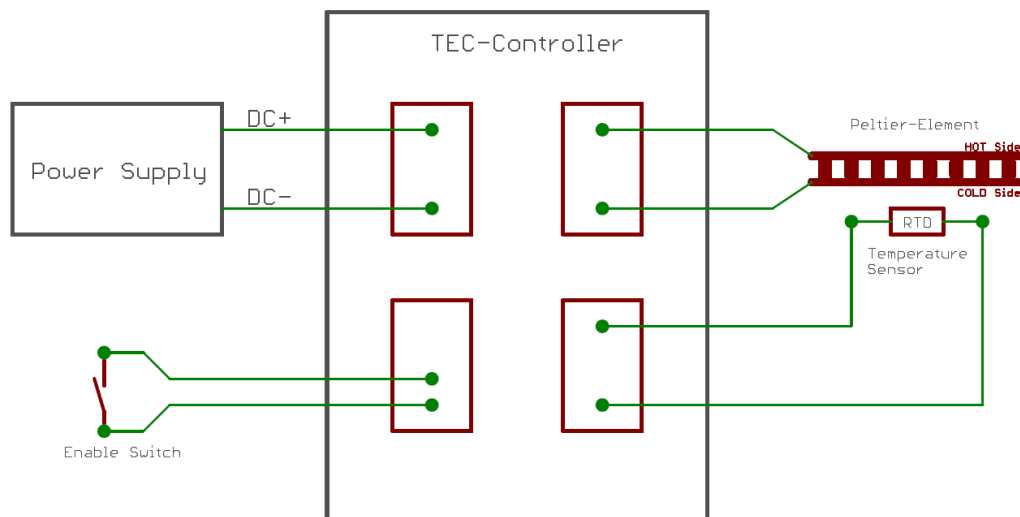



Fig. 1: Minimal TEC-Controller System

For a straightforward minimal system, beyond the mechanical setup a power supply, the Peltier Element(s), the temperature sensor and an enable switch are needed.

MESSTEC Power Converter GmbH			
Operating Manual TEC-Controller 3A			
Document: 101001200M	Revision: 1.0	Date: 19.09.2022	Page 6/71

There is a PC-Software available which provides access to comprehensive configuration, control and live monitoring menus.

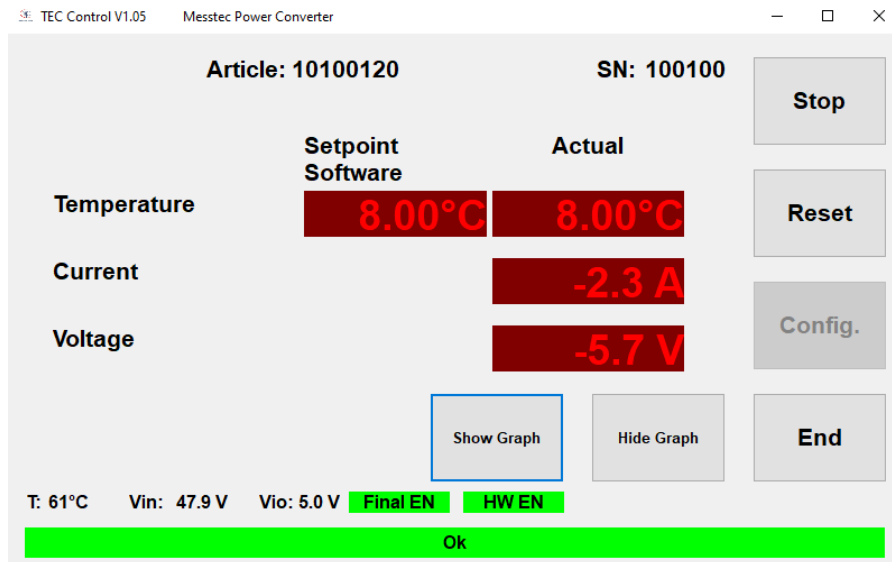



Fig. 2: PC-Software

MESSTEC Power Converter GmbH			
Operating Manual TEC-Controller 3A			
Document: 101001200M	Revision: 1.0	Date: 19.09.2022	Page 7/71

2. First steps – Getting started

- Take care of correct supply voltage wiring (X5). The TEC-Controller has no inverse polarity protection. Wrong polarity may damage the unit and will void the warranty.
- Take care of short supply voltage wiring (X5). Long cables or routing along electromagnetic interference sources will lead to instability and unreliable operating behavior.
- Do not operate a Peltier element in the range of its maximum power limit or cooling capacity. This will fail due to high power loss and bad efficiency.
- **It is recommended to select a Peltier element whose cooling capacity is sufficient at an operating voltage (current) of one quarter to half of the maximum operating voltage (current).**
- Orientation of the Peltier Element in the mechanical setup:
COLD side towards diode or heat spreader and temperature sensor
HOT side towards heatsink

MESSTEC Power Converter GmbH			
Operating Manual TEC-Controller 3A			
Document: 101001200M	Revision: 1.0	Date: 19.09.2022	Page 8/71

3. TEC-Controller

In the following, main functions are explained on the basis of the block diagram Fig. 3.

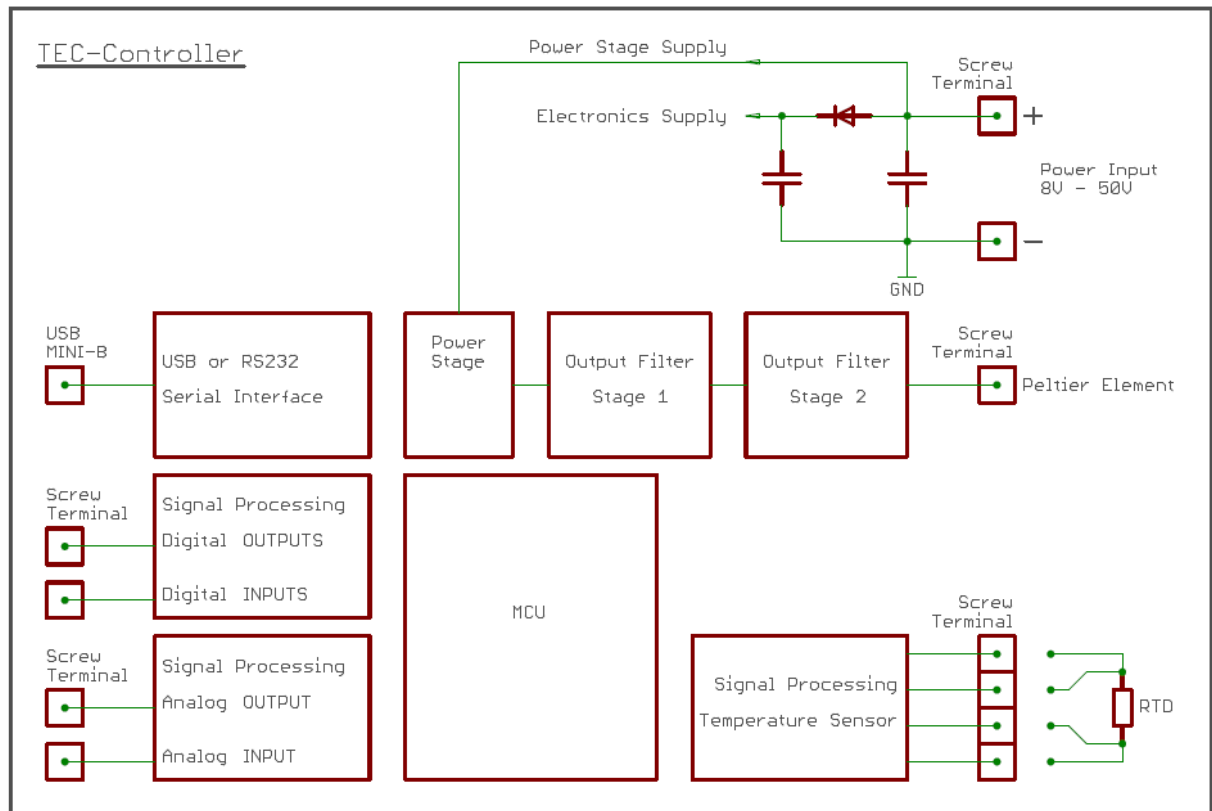

Fig. 3: Block diagram

All connections to the TEC-Controller, except the serial interface, are realized by similar and easy to use screw terminals. For easy cabling no special connectors are necessary, special tools are not required.

The power input terminal accepts voltages between 8 VDC and 50 VDC. The power supply should have stabilized voltage outputs. Make sure, the wiring is short and has correct polarity.

With high efficiency, the input voltage is processed by the power stage, according to the digital temperature controller. After extensive filtering in two stages the resulting voltage is applied to the terminal for the Peltier element. The Peltier element is driven by a DC signal. The current ripple is below 1%. The power stage is protected by a short circuit detector, which is implemented in hardware (no software latency).

Supplementary detailed information:

Based on the physical characteristics, every Peltier element has fundamental limitations on the maximum temperature difference it can create between its cold and hot side. The ability to create this maximum temperature difference is quite substantially affected by the amount of ripple current that flows through the Peltier element, relative to the DC current.

MESSTEC Power Converter GmbH			
Operating Manual TEC-Controller 3A			
Document: 101001200M	Revision: 1.0	Date: 19.09.2022	Page 9/71

This is the reason, MPC TEC-Controllers are designed for uncompromising low output current ripple, even though this is associated with higher complexity. The result is clear: Full performance of the Peltier element due to unconstrained maximum temperature difference operation. The resulting cooling system setup has therefore high efficiency and is cost effective.

PWM based TEC-Controllers are small and on its own, may have slightly higher efficiency. However the performance of the Peltier element operated in this way is really bad. In the best case, the Peltier element can create a maximum temperature difference of 50% compared to DC operation. Usually it is even less. Therefore it is required to provide larger Peltier elements, a larger power supply and larger heatsink and blower equipment. The resulting cooling system setup has therefore low efficiency and on the whole is not cost effective at all.

Signal processing for the temperature sensor is optimized for RTD (Resistance Temperature Detector) sensors. RTDs are passive devices as, Platinum, Nickel, NTC or Silicone sensors. In any case, active or integrated circuit sensors are not appropriate. Two and four wire connection is possible. Use four wire cabling with shield for high precision demands. The type of sensor can be selected conveniently by PC-Software. It is also possible to define an application specific RTD sensor.

The design of the sensor signal processing circuit ensures very high precision and virtually no drift errors. There is no need for calibration. Signal processing for the temperature sensor has open-sensor and short-circuit detection. In either case, the TEC-Controller goes into error mode and will be disabled.

For the TEC-Controller operation, there are 4 sorts of control signals and corresponding signal processing available:

- analog input, with associated reference voltage output (5 V)
- analog output
- digital input
- digital output

There is one analog input available to specify the HW-setpoint. Dependent on the actual configuration (PC-software), the temperature setpoint can be determined by an analog control voltage (0 V to 5 V) attached to the HW-setpoint input. With default settings, the analog control voltage results in a temperature setpoint of 0 °C to 50 °C, i.e. 1,5 V input voltage creates a temperature setpoint of 15 °C. The analog control voltage can be externally generated and made available in various ways. For easy operation with minimal wiring effort, there is also an internal potentiometer available. The analog input for the HW-setpoint can be configured extensively (see: Configuration in Detail).

Depending on the actual configuration, the temperature setpoint can also be adjusted directly in the GUI of the PC-software. Then no wiring of the analog HW-setpoint input is necessary at all.

Note: Highest control accuracy will be achieved in the SW SETPOINT MODE.

There is one analog output available, which gives a linear voltage from 0 V to 5 V in proportion to the actual temperature (i.e. 1,6 V corresponds to 16 °C).

MESSTEC Power Converter GmbH			
Operating Manual TEC-Controller 3A			
Document: 101001200M	Revision: 1.0	Date: 19.09.2022	Page 10/71

There are two digital inputs available: HW-ENABLE and HW-RESET. Both digital inputs can be independently configured (PC-software) as low- or high-active. Default setting is low-active. With the input HW-ENABLE activated, the TEC-Controller's power stage and closed loop temperature regulation is activated. With the input HW-RESET, internal error states of the TEC-Controller can be cleared. This is not a reset signal of the built in MCU (Micro Controller Unit).

There are two digital outputs available: READY and STATUS. Both digital outputs can be independently configured (PC-software) as low- or high-active, furthermore as totem-pole or open-collector outputs (default settings: high-active and totem-pole). The digital output READY indicates operational readiness (after power on). When internal errors are occurring, the READY output will be deactivated. The digital output STATUS will be activated, when the TEC-Controller is enabled and if the sensor temperature is within +/- 1 °C of the setpoint value.

The serial interface is carried out by standard USB 2.0 Mini-B connector. TEC-Controllers are available in two different hardware versions: with USB-Interface or with RS232 Interface. Both interface types are operating with the Mini-B connector.

PCs with USB interface are connected via standard USB cable. PCs or arbitrary controllers with RS232 interface are connected through an adapter cable Mini-B / SubD9F. This adapter cable has standard pinning on the SubD9F connector and is available on request (see chapter 7.3.7).

In any case, the serial protocol is identical. The protocol specification is available on request as a separate document.

MESSTEC Power Converter GmbH			
Operating Manual TEC-Controller 3A			
Document: 101001200M	Revision: 1.0	Date: 19.09.2022	Page 11/71

4. The Setup – General Instructions

4.1. Mechanical Setup

Fig. 4 shows a general setup of a laser diode system and its appropriate cooling equipment. Here, just the mere schematic mechanical setup is drafted.

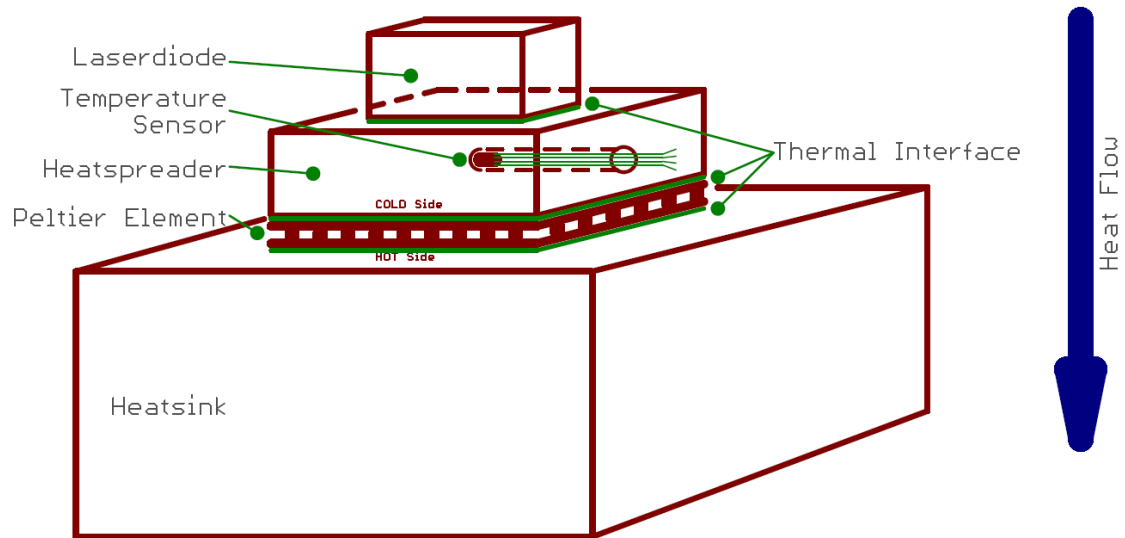

Fig. 4: General Setup

The general setup consists of:

- laser diode
- Heatspreader with integrated temperature sensor
- Peltier Element
- Heatsink

The laser diode as the heat source in this setup has to be mounted on an appropriate heatspreader. The heatspreader (also called cooling plate) is a solid block, made of copper or aluminum.

Usually the base area of the heatspreader is larger than that of the Peltier Element because of the required mounting holes. The temperature sensor is positioned inside the heatspreader. For this purpose an appropriate hole or notch has to be machined into the heatspreader directly below the laser diode. Make sure, the temperature sensor is properly fixed and has best thermal contact (use gap-filler or thermally conductive glue). Use a temperature sensor with small thermal mass.

Note: Design and workmanship of the heatspreader and the location of the temperature sensor in the heatspreader has great impact on the final quality and stability of the closed loop control of the temperature.

MESSTEC Power Converter GmbH			
Operating Manual TEC-Controller 3A			
Document: 101001200M	Revision: 1.0	Date: 19.09.2022	Page 12/71

The Peltier Element is located in between the heatspreader and the heatsink.

Note: It is absolutely essential, the cold side of the Peltier Element is aligned towards the heatspreader and the hot side is aligned towards the heatsink. Wrong assembly will yield in total malfunction and instability of the system, and may further damage your setup.

Finally, with its hot side, the Peltier Element is mounted to the heatsink. Make sure the heatsink is designed large enough to well dissipate all the heat produced in the system setup.

Pay attention that all joints within the heat flow feature lowest possible heat resistance. Use adequate thermal interface materials like gap-filler, thermal compounds or thermal conductive foil.

MESSTEC Power Converter GmbH			
Operating Manual TEC-Controller 3A			
Document: 101001200M	Revision: 1.0	Date: 19.09.2022	Page 13/71

4.2. Electrical Setup for Control and Monitoring

In the following some generic wiring examples are shown.

The power supply, Peltier element and temperature sensor are wired in the same way in all examples.

An Enable switch is wired to the HW ENABLE input in all examples. This is due to the fact, that even if the ENABLE Mode is set to SW (PC-Software), it is still necessary to activate the HW ENABLE input for safety reasons (see "Control Signals Digital X2"). It is not recommended, to replace the switch by a wire bridge.

A Reset switch is wired to the RESET input in all examples. In normal operation this switch is namely not necessary. But in case of failure, the Reset switch is essential to be able to clear errors and subsequently continue operation. Alternatively, if the TEC-Controller is operated by PC-Software, there is also a Reset button available in the GUI.

In the following, some sample applications are shown:

Fig. 5

The internal setpoint potentiometer is applied. Therefore a simple wire bridge must be installed.

Fig. 6

An external setpoint potentiometer is installed. Please also note chapter "Wiring examples for the analog input CA-SETPOINT".

Fig. 7

The HW ENABLE input is set to High-active in the IO-configuration (PC-Software). Therefore, the Enable switch is wired to +5V REFERENCE. In any case, a pullup or rather pulldown resistor is not necessary.

Fig. 8

The SETPOINT MODE is set to SW (software). Now, the temperature setpoint is adjusted in the GUI of the PC-Software. Wiring of the HW SETPOINT input can be omitted completely.

Fig. 9

The output signals READY and STATUS are wired to external LEDs.

Fig. 10

The output signals READY and STATUS are wired to external relays. They are powered by a separate power supply. Make sure, the outputs are configured to OC (open collector) in this case. Output sink current is max. 500 mA in OC mode.

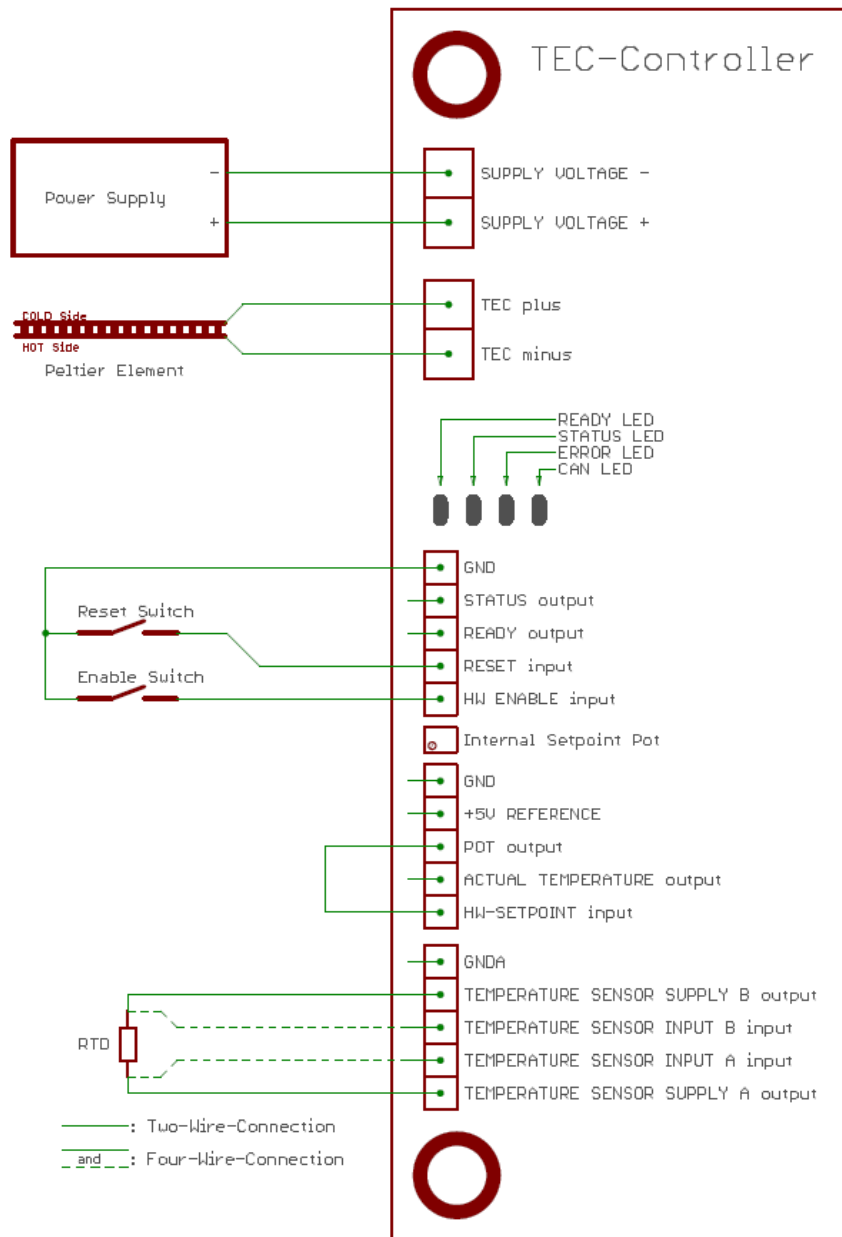

Fig. 5: Wiring example with internal setpoint potentiometer

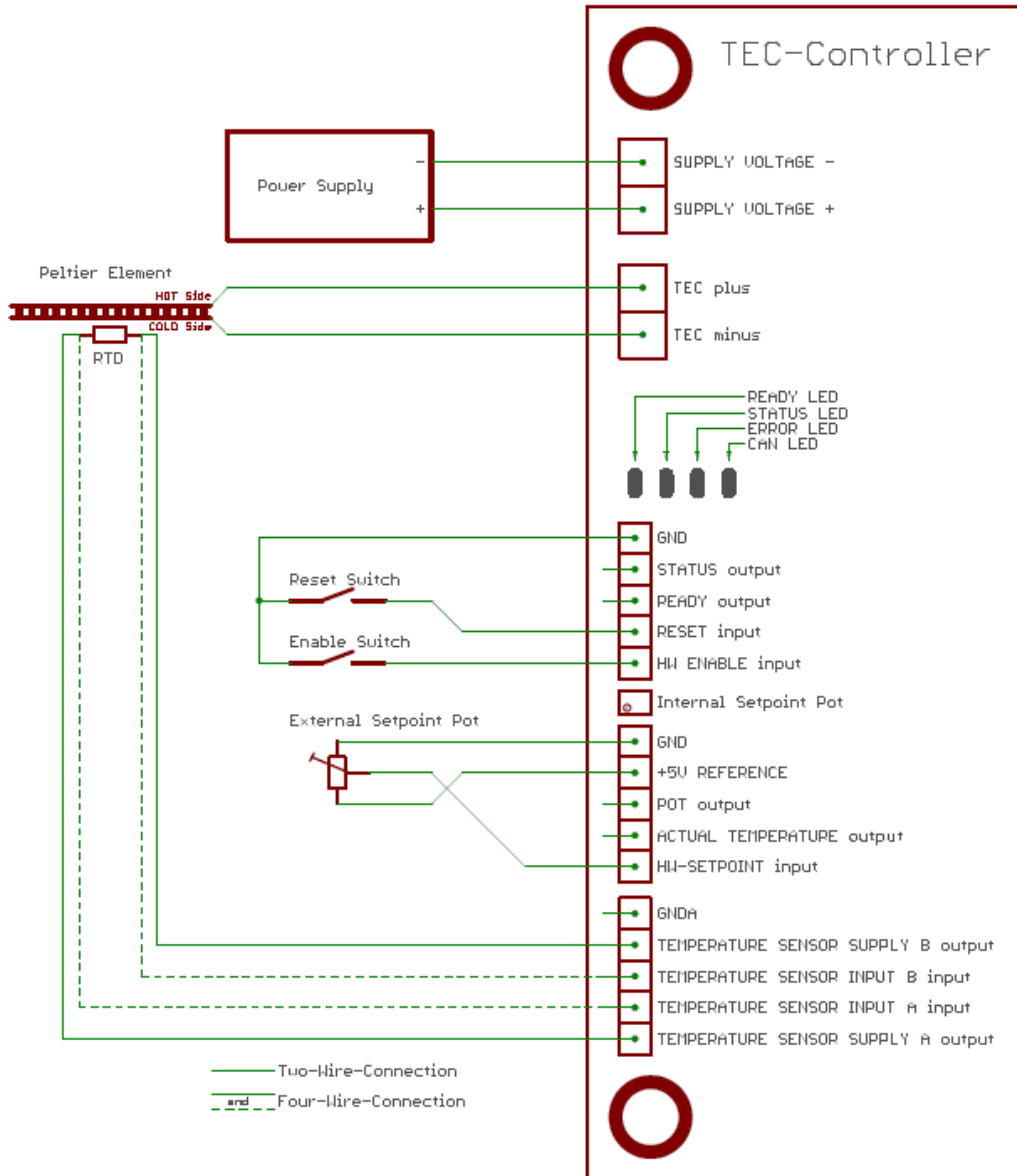

Fig. 6: Wiring example with external setpoint potentiometer

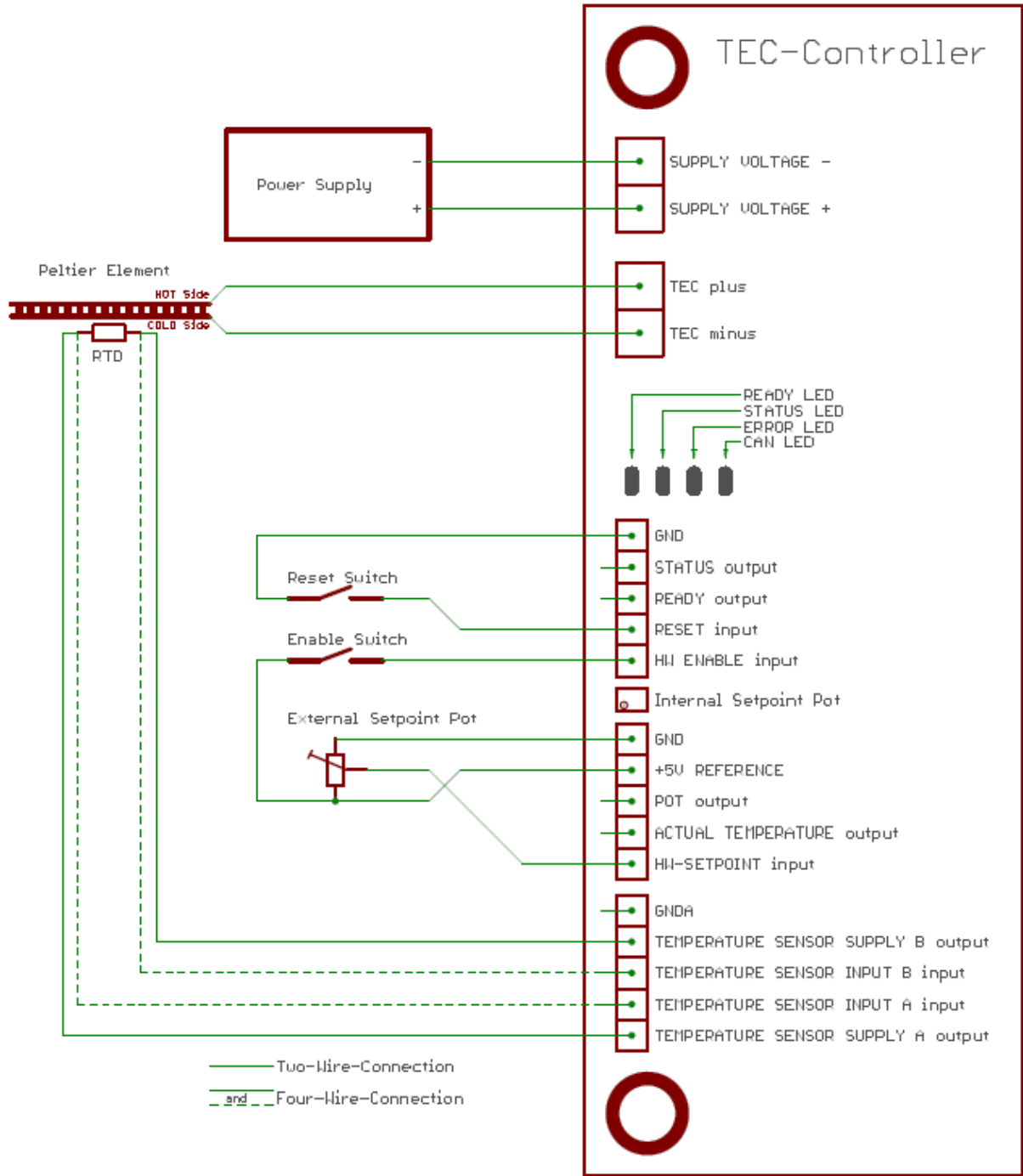

Fig. 7: Wiring example: HW ENABLE input is high active

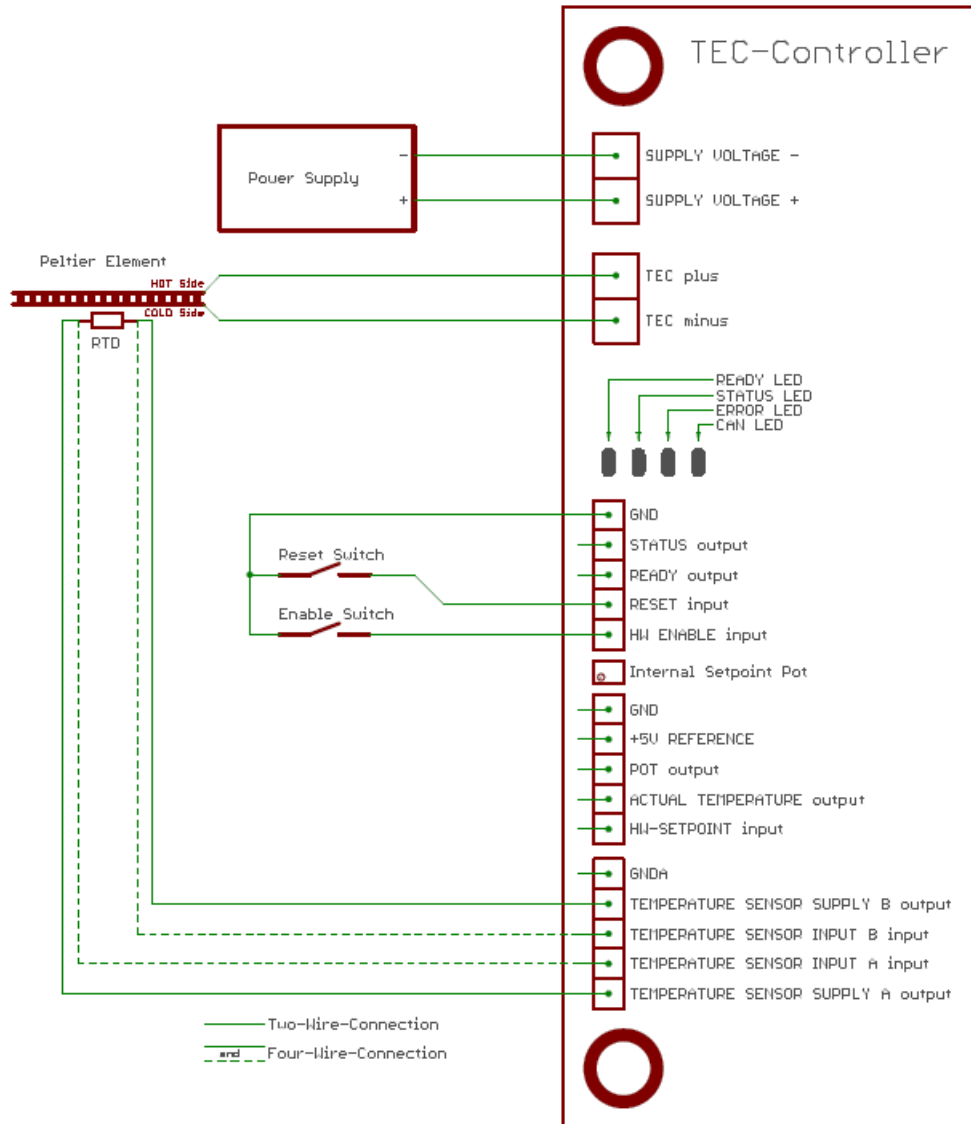

Fig. 8: Wiring example: setpoint mode via Control Software

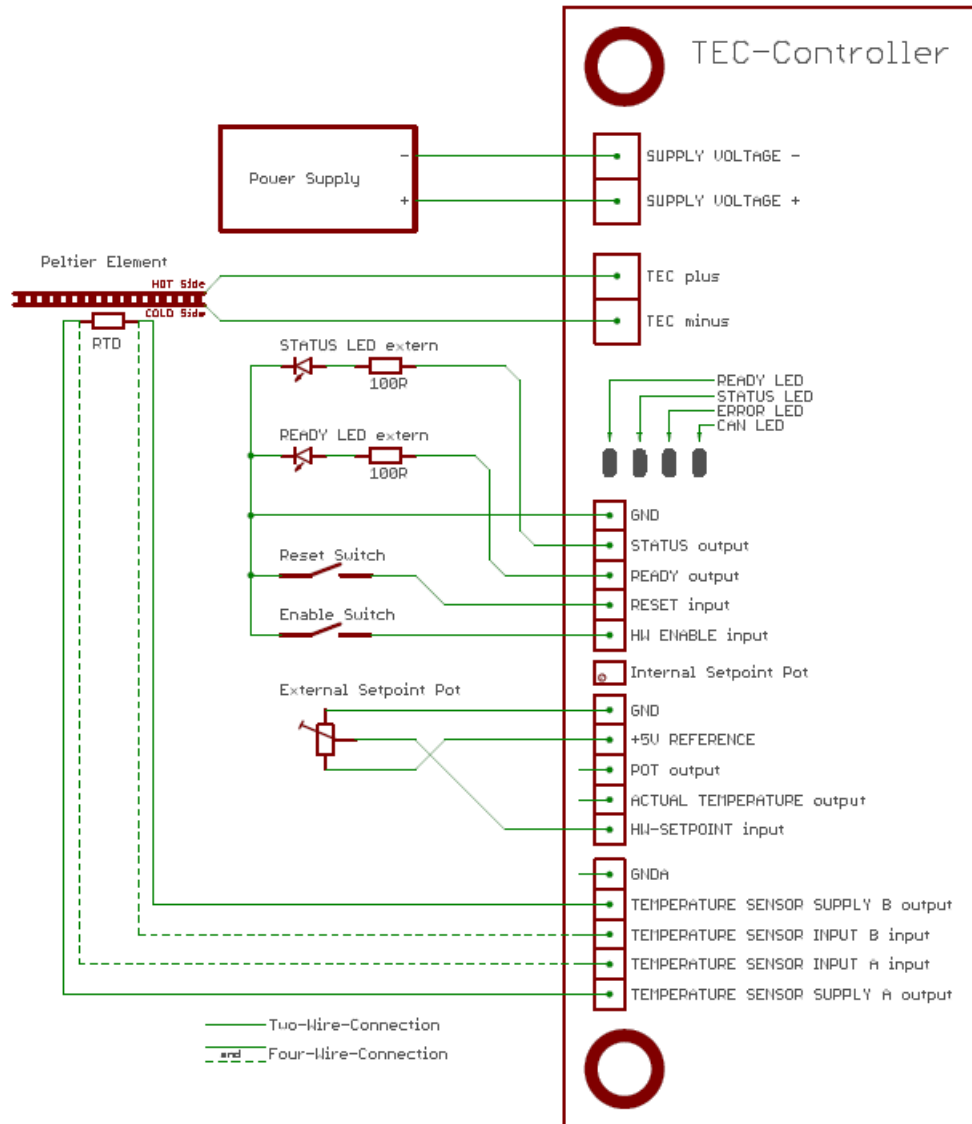

Fig. 9: Wiring example: external READY and STATUS LEDs

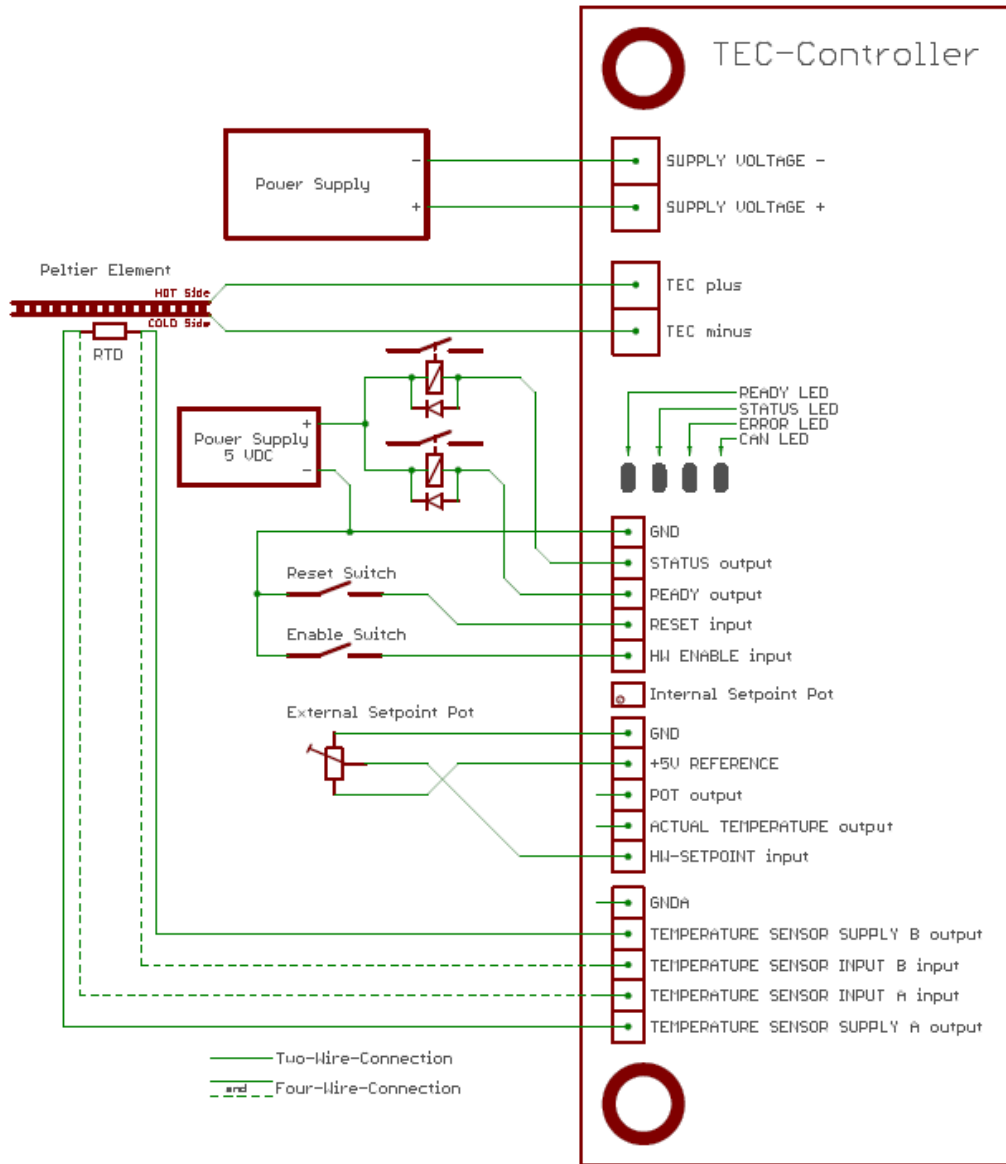



Fig. 10: Wiring example: external READY and STATUS relays

MESSTEC Power Converter GmbH			
Operating Manual TEC-Controller 3A			
Document: 101001200M	Revision: 1.0	Date: 19.09.2022	Page 20/71

5. Temperature sensor

The TEC-Controller has a very accurate and progressive sensor signal processing unit onboard. This signal processing unit is able to accept RTD temperature sensors of almost any technology. Sensor interface wiring can be realized in a 2-wire or 4-wire system.

Note: For highest demands in temperature accuracy it is recommended to consider an appropriate Pt1000 sensor in a 4-wire system.

For wiring details please see chapter "Wiring and connectors / Temperature Sensor X4".

The type of sensor applied in the setup can be configured by means of PC-Software.

Note: The default sensor type is Pt1000.

5.1. Platinum Sensor

In the PC-Software Pt1000 and Pt100 Sensors are available. It is not necessary to enter any coefficients, just press the button for the sensor in your application (see Fig. 11 below).

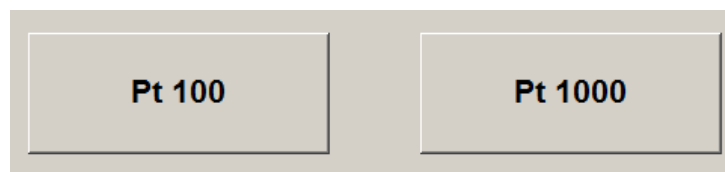

Fig. 11: Platinum sensor selection

Supplementary detailed information:

Platinum Sensors have a characteristic curve according to:

$$R(\vartheta) = R_{\vartheta_0} * (1 + a * (\vartheta - \vartheta_0) + b * (\vartheta - \vartheta_0)^2)$$

$$a = 3,9083 * 10^{-3} * \text{°C}^{-1}$$

$$b = -5,775 * 10^{-7} * \text{°C}^{-2}$$

ϑ : Temperature in °C

ϑ_0 : Reference temperature in °C ($\vartheta_0 = 0 \text{ °C}$ for Platinum)

R_{ϑ_0} : Reference resistor value in Ω (Pt1000: $R_{\vartheta_0} = 1000 \Omega$)

MESSTEC Power Converter GmbH			
Operating Manual TEC-Controller 3A			
Document: 101001200M	Revision: 1.0	Date: 19.09.2022	Page 21/71

5.2. Nickel Sensor

In the PC-Software Ni1000 and Ni100 Sensors are available. It is not necessary to enter any coefficients, just press the button for the sensor in your application (see Fig. 12 below).



Fig. 12: Nickel sensor selection

Supplementary detailed information:

Nickel Sensors have a characteristic curve according to:

$$R(\vartheta) = R_{\vartheta_0} * (1 + a * (\vartheta - \vartheta_0) + b * (\vartheta - \vartheta_0)^2 + c * (\vartheta - \vartheta_0)^4 + d * (\vartheta - \vartheta_0)^6)$$

$$a = 5,485 * 10^{-3} * \text{°C}^{-1}$$

$$b = 6,650 * 10^{-6} * \text{°C}^{-2}$$

$$c = 2,805 * 10^{-11} * \text{°C}^{-4}$$

$$d = -2.00 * 10^{-17} * \text{°C}^{-6}$$

ϑ : Temperature in °C

ϑ_0 : Reference temperature in °C ($\vartheta_0 = 0 \text{ °C}$ for Nickel)

R_{ϑ_0} : Reference resistor value in Ω (Ni1000: $R_{\vartheta_0} = 1000 \Omega$)

5.3. NTC

In the PC-Software just enter parameter values for the NTC-Sensor, which are available from the device datasheet (see Fig. 13 below).

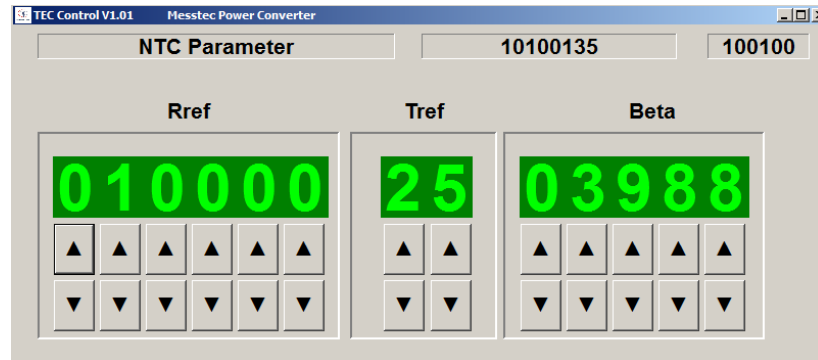

Fig. 13: NTC sensor parameters

Supplementary detailed information:

NTC sensors have a characteristic curve according to:

$$R_{\vartheta} = R_{ref} * e^{B * \left(\frac{1}{\vartheta} - \frac{1}{T_{ref}} \right)}$$

R_{ref} : Reference resistor value in Ω

B : Beta value in K

ϑ : Temperature in K

T_{ref} : Reference temperature in K

Note: The TEC-Controller firmware always converts Kelvin to °Celsius. The user never has to hassle with Kelvin values.

MESSTEC Power Converter GmbH			
Operating Manual TEC-Controller 3A			
Document: 101001200M	Revision: 1.0	Date: 19.09.2022	Page 23/71

5.4. Silicon Sensor (KTY11-5)

In the PC-Software the silicon sensor KTY11-5 is available. It is not necessary to enter any coefficients, just press the button for the sensor in your application (see Fig. 14 below).

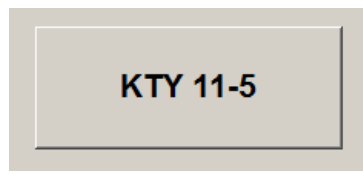

Fig. 14: Silicone sensor selection

Supplementary detailed information:

Silicon Sensors have a characteristic curve according to:

$$R(\vartheta) = R_{\vartheta_0} * (1 + a * (\vartheta - \vartheta_0) + b * (\vartheta - \vartheta_0)^2)$$

$$a = 7,880 * 10^{-3} * ^\circ\text{C}^{-1}$$

$$b = 1,937 * 10^{-5} * ^\circ\text{C}^{-2}$$

ϑ : Temperature in $^\circ\text{C}$

ϑ_0 : Reference temperature in $^\circ\text{C}$ ($\vartheta_0 = 25\text{ }^\circ\text{C}$ for KTY11 sensors)

R_{ϑ_0} : Reference resistor value in Ω (KTY11-5: $R_{\vartheta_0} = 1970\ \Omega$)

MESSTEC Power Converter GmbH			
Operating Manual TEC-Controller 3A			
Document: 101001200M	Revision: 1.0	Date: 19.09.2022	Page 24/71

5.5. Arbitrary Sensor

Almost any arbitrary temperature sensor can be used in specific applications.

Note: The temperature sensor interface and signal processing is designed for RTD (Resistance Temperature Detector) sensors. Do not use active or integrated circuit temperature sensors in any case!

Arbitrary sensors are specified via polynomial of 6th degree. The characteristic curve is according to:

$$R(\vartheta) = R_{\vartheta_0} * (1 + a_1 * (\vartheta - \vartheta_0) + a_2 * (\vartheta - \vartheta_0)^2 + a_3 * (\vartheta - \vartheta_0)^3 + a_4 * (\vartheta - \vartheta_0)^4 + a_5 * (\vartheta - \vartheta_0)^5 + a_6 * (\vartheta - \vartheta_0)^6)$$

a_1 = coefficient 1st order; unit: °C⁻¹
 a_2 = coefficient 2nd order; unit: °C⁻²
 a_3 = coefficient 3rd order; unit: °C⁻³
 a_4 = coefficient 4th order; unit: °C⁻⁴
 a_5 = coefficient 5th order; unit: °C⁻⁵
 a_6 = coefficient 6th order; unit: °C⁻⁶

ϑ : Temperature in °C

ϑ_0 : Reference temperature in °C

R_{ϑ_0} : Reference resistor value in Ω ($R_{\vartheta_0} = R(\vartheta)$ at ϑ_0)

The configuration of arbitrary sensors allows a high degree of variety. Not all values and combinations are really reasonable.

Make sure to consider the following notes:

- The result of the polynomial always must be positive in the range 0 °C to 50 °C.
- The curve shape of the polynomial must be always strictly monotonic decreasing or increasing.
- The result of the polynomial should be located in a range 100 Ω to 5 k Ω .

In the PC-Software the arbitrary sensor can be configured according to Fig. 15 and Fig. 16. To select a coefficient, click on the value (right side) of a coefficient.

The default setting corresponds to the sensor Pt1000.

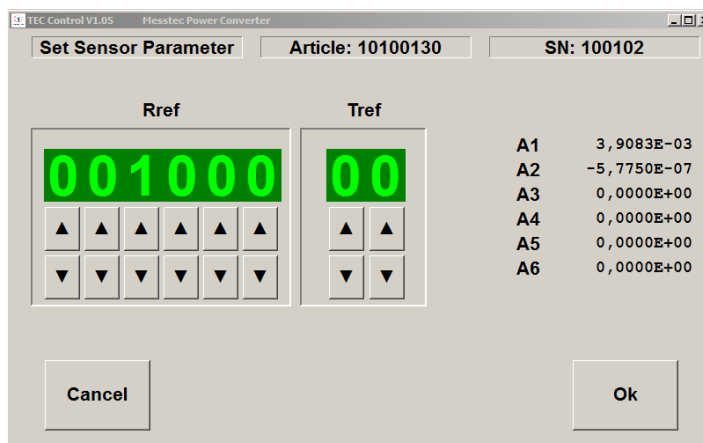

Fig. 15: Arbitrary sensor definition page 1

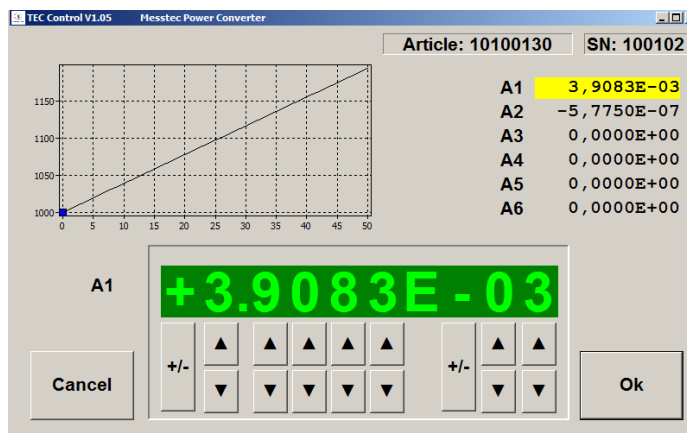



Fig. 16: Arbitrary sensor definition page 2

MESSTEC Power Converter GmbH			
Operating Manual TEC-Controller 3A			
Document: 101001200M	Revision: 1.0	Date: 19.09.2022	Page 26/71

5.6. Sensor Current

The current source for the temperature sensor is adjustable between 100 µA and 4 mA. Default setting is 1 mA.

Note: For almost all sensors, the default setting fits very well. It is therefore not necessary to alter the sensor current. In seldom cases, especially with specific sensors (see chapter Arbitrary Sensor) it may be necessary to alter the sensor current to optimize the measurement results.

Supplementary detailed information:

The current through the temperature sensor is always the result of a reasonable compromise. Conflicting requirements are:

- *Maximized sensor output signal hence optimized resolution*
- *Minimized sensor power hence self-heating*
- *Sensor signal processing has upper and lower limits*

It is a common rule of thumb, to limit the load of the sensor to 1 mW. With this value self-heating of the sensor device is acceptable low and the sensor output signal is high enough for precision signal processing.

Sensor signal processing limits are:

- U_{MIN} : 0,08 V
- U_{MAX} : 2,30 V

Sensor voltages below U_{MIN} are considered as short-circuit in the sensor circuit. Sensor voltages above U_{MAX} are considered as broken wire in the sensor circuit. A sensor error is released in both cases.

For the sensor current we have:

$$I_{SENSOR MAX} = \sqrt{\frac{P_{SENSOR MAX}}{R_{SENSOR}}}$$

and

$$U_{SENSOR} = R_{SENSOR} * I_{SENSOR}$$

Example:

What is the current value for a Pt1000 sensor, when the power dissipation is supposed to be 1 mW?

$$I_{SENSOR} = \sqrt{\frac{0,001 W}{1000 \Omega}} = 1 mA$$

$$U_{SENSOR} = 1000 \Omega * 1 mA = 1,0 V$$

Result:

The proposed sensor current is 1 mA.

The sensor voltage is 1 V. This is very well between the two limits U_{MAX} and U_{MIN} .

MESSTEC Power Converter GmbH			
Operating Manual TEC-Controller 3A			
Document: 101001200M	Revision: 1.0	Date: 19.09.2022	Page 27/71

6. Indicator elements

There are 3 different groups of LED indicators:

- Indication of operating states
- Indication of serial data transfer
- Monitoring of supply voltages

6.1. Indication of operating states

6.1.1. Indicator LEDs

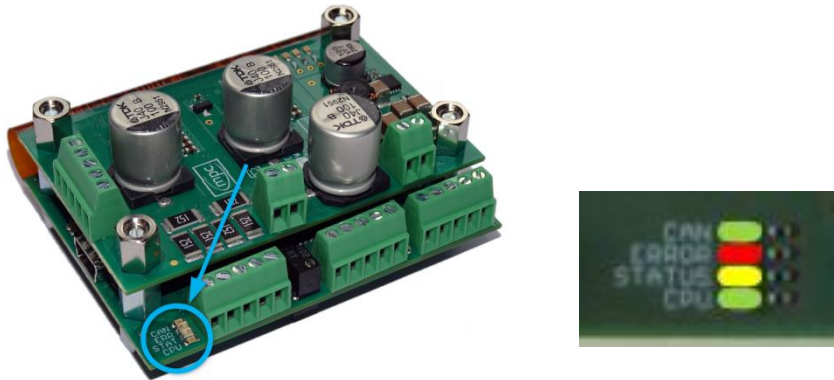

Fig. 17: Operating states indicator LEDs

CAN LED

Currently not used.

ERROR LED

Indication of error states.

- LED Off: no error
- LED one flash: Sensor error (short circuit or open sensor wiring)
- LED two flashes: Output current too high (external short circuit)
- LED three flashes: internal over temperature of power stage

Description of error states see chapter: Error States.

MESSTEC Power Converter GmbH			
Operating Manual TEC-Controller 3A			
Document: 101001200M	Revision: 1.0	Date: 19.09.2022	Page 28/71

STATUS LED

Indication temperature controller.

- LED Off: TEC-Controller is disabled. ENABLE not active.
- LED On: TEC-Controller is enabled
AND
temperature is within +/- 1 °C of the setpoint value
- LED one flash: TEC-Controller is enabled
AND
temperature is below setpoint (too cold).
- LED two flashes: TEC-Controller is enabled
AND
temperature is above setpoint (too hot).

CPU LED

After power up and the booting sequence, this LED is blinking periodically, indicating the processor is working properly. The TEC-Controller is operating normally.

Note: If this LED shows different behavior, the TEC-Controller is not operating normally. Do NOT enable the TEC-Controller in this case.

6.1.2. Booting sequence

After power up the processor runs through a booting sequence. During this sequence, the internal and external hardware is entirely configured and put into full operation.

This sequence is accompanied by a LED test sequence, which behaves like a traffic light. These LEDs are switched on and off sequentially:

1st: **RED**
2nd: **YELLOW**
3rd: **GREEN**

After this sequence, the TEC-Controller is in normal operation.

MESSTEC Power Converter GmbH			
Operating Manual TEC-Controller 3A			
Document: 101001200M	Revision: 1.0	Date: 19.09.2022	Page 29/71

6.1.3. Safe-State during configuration of digital Inputs/Outputs

The Safe-State is indicated by simultaneously and periodically blinking of three LEDs:

RED
YELLOW
GREEN

The Safe-State can be left only by switching off the power supply of the TEC-Controller.

6.2. Indication of serial data transfer

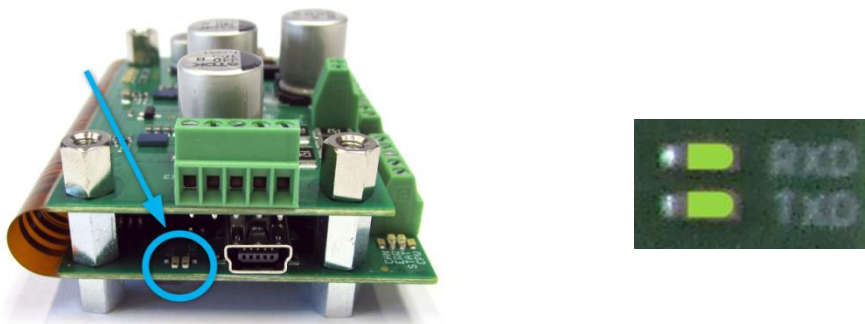



Fig. 18: Serial data transfer indicator LEDs

During serial data transfer (USB or RS232) to PC or external controller, these LEDs are flashing accordingly.

- RXD flashing: data is being received
- TXD flashing: data is being transmitted

While connected to the PC-Software, both LEDs are flashing periodically.

MESSTEC Power Converter GmbH			
Operating Manual TEC-Controller 3A			
Document: 101001200M	Revision: 1.0	Date: 19.09.2022	Page 30/71

6.3. Monitoring of supply voltages

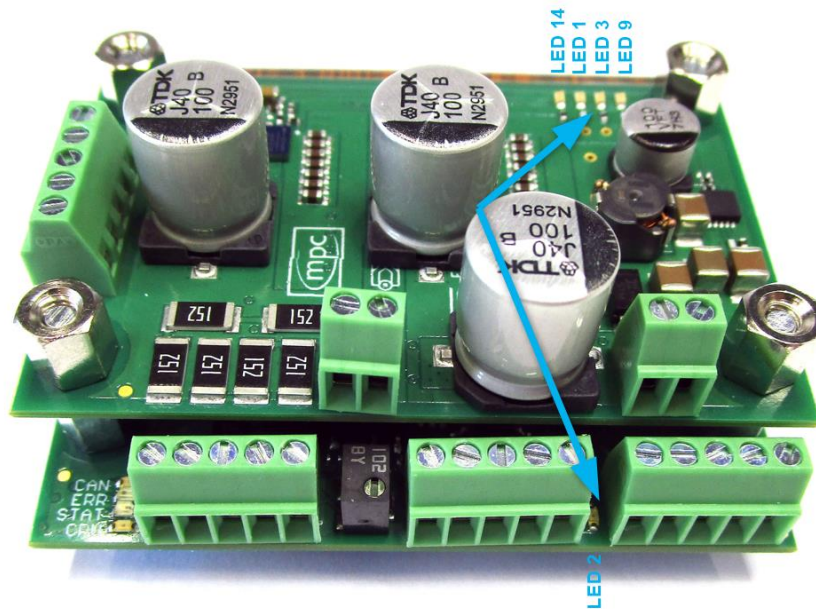

Fig. 19: Supply voltage monitor LEDs

These LEDs provide simple means for monitoring internal supply voltages. In any case, all LEDs must be constantly ON.

- LED 1: +5 V sensor signal processing
- LED 2: +5 V i/o reference voltage
- LED 3: +3,3 V
- LED 9: +5 V
- LED 14: +6 V

Note: LED 2 monitors the reference voltage for the HW-SETPOINT. If this LED is Off, double check the wiring of the external setpoint potentiometer. The reference voltage may be short circuit.

7. **Wiring and connectors**

7.1. **Hookup groups**

Three groups of hookups are available to operate the TEC-Controller:

- Power (small screw-type connectors)
- Control and temperature sensor (small screw-type connectors)
- PC interface (USB 2.0 Mini-B connector)

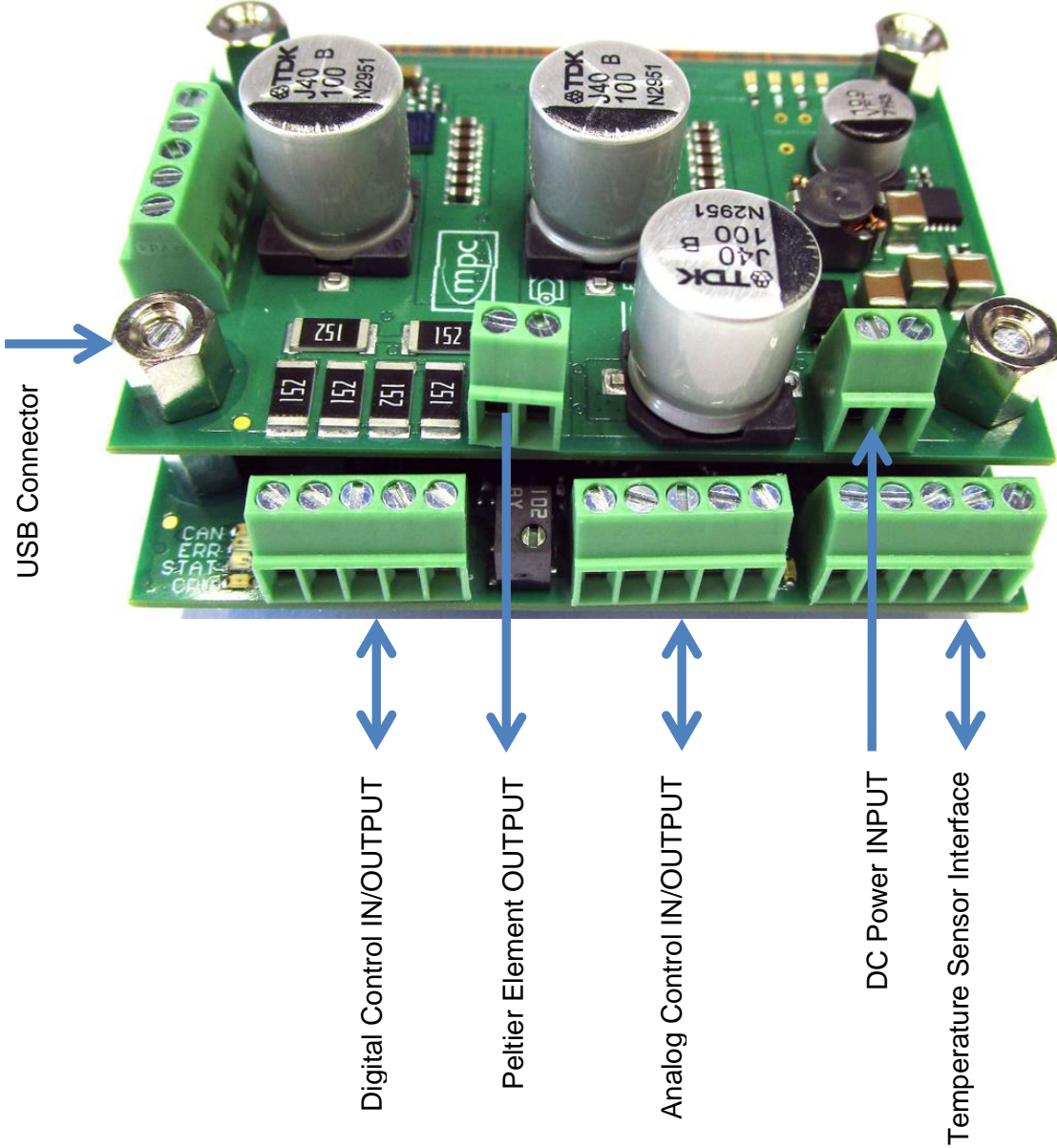
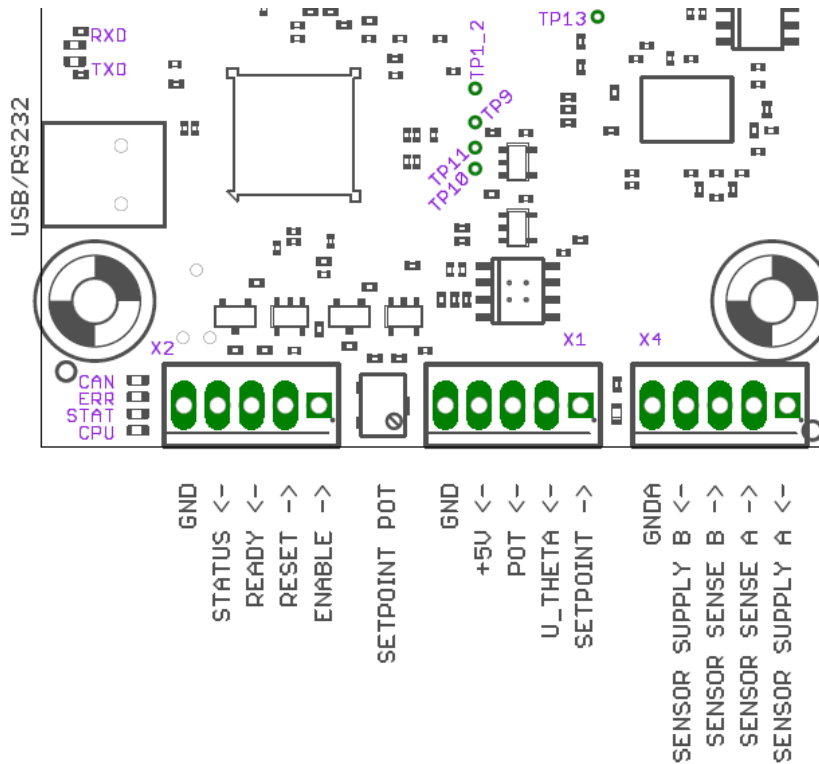

Fig. 20: Hookup groups

7.2. Connectors and signals

Lower Board:



Connectors (lower board)

- X2 5-pole single row screw terminal. Control signals digital.
- X1 5-pole single row screw terminal. Control signals analog.
- X4 5-pole single row screw terminal. Temperature sensor.
- USB/RS232 USB 2.0 Mini-B connector

Upper Board:

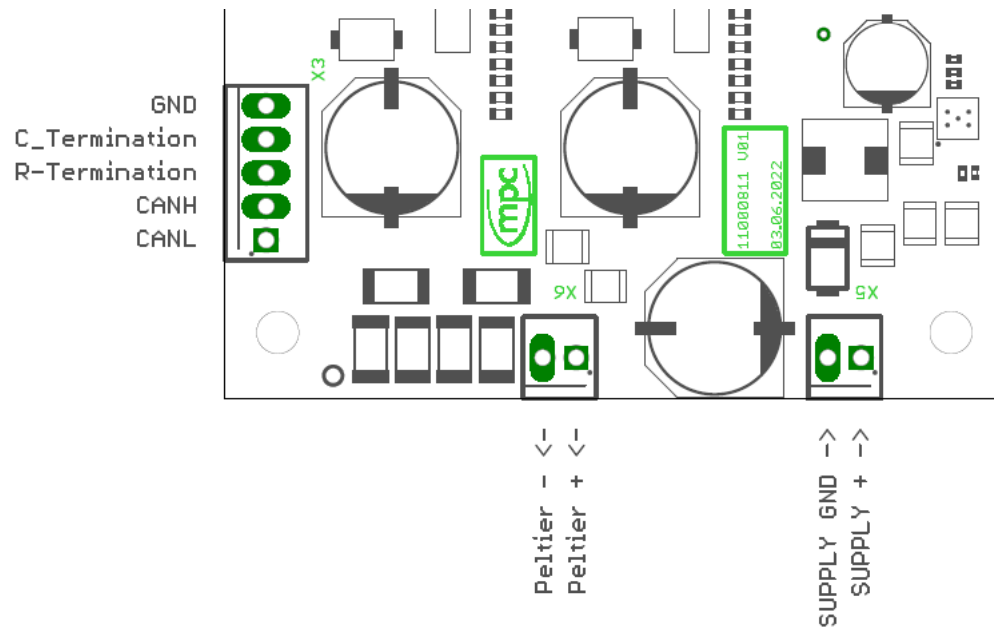

Connectors (upper board)

- X5 2-pole single row screw terminal. Input for supply voltage.
- X6 2-pole single row screw terminal. Output to Peltier Element.
- X3 5-pole single row screw terminal. CAN interface

MESSTEC Power Converter GmbH			
Operating Manual TEC-Controller 3A			
Document: 101001200M	Revision: 1.0	Date: 19.09.2022	Page 34/71

7.2.1. Supply Voltage X5

Pin	Name	Function
1	SV+	Supply voltage plus
2	GND	Power GND (supply voltage minus)

SV+ (X5-1)

Supply voltage plus

Supply voltage: 8.0 V ... 48.0 V (max. 50 V)

Supply current: depends on the output load (max. ~3,5A)

There are no internal fuses. The supply voltage has to be fused external. Supply voltage should be approx. 10% above maximum Peltier voltage. Make sure that the supply wiring (SV+ and GND) is as short as possible.

Warning: There is no inverse polarity protection for the supply voltage. Wrong polarity may damage the device substantially. This will void the warranty.

GND (X5-2)

Power GND related to SV+.

Connect to supply voltage minus.

7.2.2. Peltier element X6

Pin	Name	Function
1	TECplus	Power output to Peltier element plus
2	TECminus	Power output to Peltier element minus

TECplus (X6-1)

Connection to Peltier element plus.

Voltage: 0 V ... Supply voltage

This output pin has to be connected to the plus pin of the Peltier element. It does not mean, that there is a positive voltage related to the output pin **TECminus**. The polarity on this outputs is dependent exclusively on the temperature control situation and is not related to GND.

Warning: Do not connect to GND or any other electrical potential.

TECminus (X6-2)

Connection to Peltier element minus.

Voltage: 0 V ... Supply voltage

This output pin has to be connected to the minus pin of the Peltier element. It does not mean, that there is a negative voltage related to the output pin **TECplus**. The polarity on this outputs is dependent exclusively on the temperature control situation and is not related to GND

Warning: Do not connect to GND or any other electrical potential.

Warning: Make sure, TECminus and TECplus are not mixed up. If so, the controller will never come into regulation and will be unstable. This can lead to sudden shock and damage of your setup.

The power outputs to the Peltier element are short circuit protected. The short circuit detector is implemented in hardware and therefore reacting fast (no software latency).

7.2.3. Control Signals Digital X2

Digital control signals can be configured in a comprehensive way. The PC-Software offers easy access to configuration of inputs and outputs. Initially, the signal description is based on default configuration. Subsequently, alternative configurations will be presented and explained.

Pin	Name	Function
1	CD-ENABLE	HW-ENABLE input, low-active (default configuration)
2	CD-RESET	HW-RESET input, low-active (default configuration)
3	CD-READY	Output, high-active (default configuration)
4	CD-STATUS	Output, high-active (default configuration)
5	GND	Signal GND

CD-ENABLE – Input (X2-1)

Control Digital – HW-ENABLE (Hardware-Enable)

Input resistance: 10 kΩ (pullup)

Digital TTL (5 V) input. High if left open.

Default configuration: low active

A low-signal or pulling HW-ENABLE to GND will start the temperature controller and the output-power-stage. The TEC-Controller is then fully activated and starts temperature regulation.

For safety reasons this signal is essential in any case. Even if the Enable-Mode is set to Software by PC-Software, in this case the HW-ENABLE and the software START-Button have to be activated. Only then, the Final-ENABLE will be set active and start the TEC-Controller in this case.

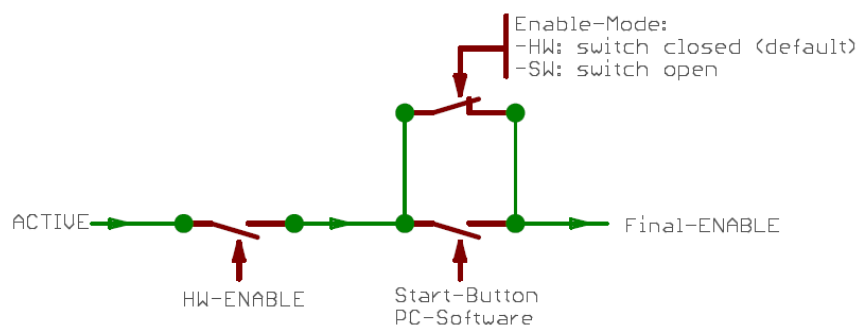



Fig. 21: internal ENABLE signal chain

Fig. 21 shows the internal logic of the ENABLE signal chain represented as an electric circuit.

If the Enable-Mode is set to HW, the logic of the Start-Button is bypassed (Enable-Mode switch closed). Consequence: just the HW-ENABLE activates the Final-ENABLE.

MESSTEC Power Converter GmbH			
Operating Manual TEC-Controller 3A			
Document: 101001200M	Revision: 1.0	Date: 19.09.2022	Page 37/71

If the Enable-Mode is set to SW, the logic of the Start-Button is not bypassed (Enable-Mode switch open). Consequence: HW-ENABLE and Start-Button only together are activating the Final-ENABLE.

CD-RESET – Input (X2-2)

Control Digital – HW-RESET (Hardware-Reset)
Input resistance: 10 k Ω (pullup)
Digital TTL (5 V) input. High if left open.
Default configuration: low active

With HW-RESET internal error states can be cleared (see Error states).

Note: The HW-RESET input is not a reset line for the MCU.

CD-READY – Output (X2-3)

Control Digital – READY
Output resistance: 330 Ω
Digital TTL (5 V) output.
Default configuration: high active

The output signal READY indicates that the TEC-Controller is working normally and that there are no error states.

READY = inactive:

- after power on: TEC-Controller is booting. Internal peripherals are put into operation.
- An error is present (i.e. broken temperature sensor).

READY = active:

- TEC-Controller is in normal working condition. No errors present.

MESSTEC Power Converter GmbH			
Operating Manual TEC-Controller 3A			
Document: 101001200M	Revision: 1.0	Date: 19.09.2022	Page 38/71

CD-STATUS – Output (X2-4)

Control Digital – STATUS

Output resistance: 330 Ω

Digital TTL (5 V) output.

Default configuration: high active

STATUS = inactive:

- TEC-Controller is disabled OR sensor temperature is outside +/- 1 °C of the setpoint value.

STATUS = active:

- TEC-Controller is enabled AND sensor temperature is within +/- 1 °C of the setpoint value.

GND – (X2-5)

Signal GND

Reference potential for CD signals.

MESSTEC Power Converter GmbH			
Operating Manual TEC-Controller 3A			
Document: 101001200M	Revision: 1.0	Date: 19.09.2022	Page 39/71

7.2.4. Control Signals Analog X1

Pin	Name	Function
1	CA-SETPOINT	HW-SETPOINT input
2	CA-U-THETA	ACTUAL TEMPERATURE output
3	CA-POT	Output of built in potentiometer (1 kΩ)
4	REFERENCE +5V	Reference voltage output
5	GND	Signal GND

CA-SETPOINT – Input (X1-1)

Control Analog – HW-SETPOINT (Hardware-Setpoint)

Input resistance: 10 kΩ

The voltage feed into this input sets the hardware-setpoint of the temperature controller.

Voltage sources for this purpose are:

- + Internal potentiometer
- + External potentiometer
- + Voltage controller

Wiring examples see below.

Note: The HW-SW-SETPOINT-MODE has to be set to HW by means of the PC Software. This is the default mode.

The target temperature (in °C) is proportional to the voltage according to the following relationship:

$$\vartheta = U_{X1-1} * 10$$

Example: 0 V => 0 °C; 2,5 V => 25 °C; 5 V => 50 °C

Note: This is true only for the default settings.

For further characteristics see: Configuration in detail – HW-Setpoint

MESSTEC Power Converter GmbH			
Operating Manual TEC-Controller 3A			
Document: 101001200M	Revision: 1.0	Date: 19.09.2022	Page 40/71

CA-U-THETA – Output (X1-2)

Control Analog – ACTUAL TEMPERATURE

Output resistance: 100 Ω

The voltage on this output is proportional to the actual sensor temperature in °C.

Relationship:

$$U_{X1-2} = \frac{\vartheta}{10}$$

Example: 0 °C => 0 V; 25 °C => 2,5 V; 50 °C => 5 V

CA-POT – Output (X1-3)

Control Analog – Output of built in setpoint potentiometer

Output resistance: 1 kΩ

REFERENCE +5V – Output (X1-4)

Control Analog – Output of reference voltage +5 V

Output current: $I_{\max} = 100\text{mA}$

GND – (X1-5)

Signal GND

Reference potential for CA signals.

7.2.5. Wiring examples for the analog input CA-SETPOINT

Note: All signals, including GND must not be connected to any external potential.

7.2.5.1. Internal Potentiometer

For a fast and convenient setup, there is a potentiometer (10 turns) onboard. This potentiometer is already connected internally to the reference voltage and GND. The only external connection has to be made between CA-POT and CA-SETPOINT (see Fig. 22 below).

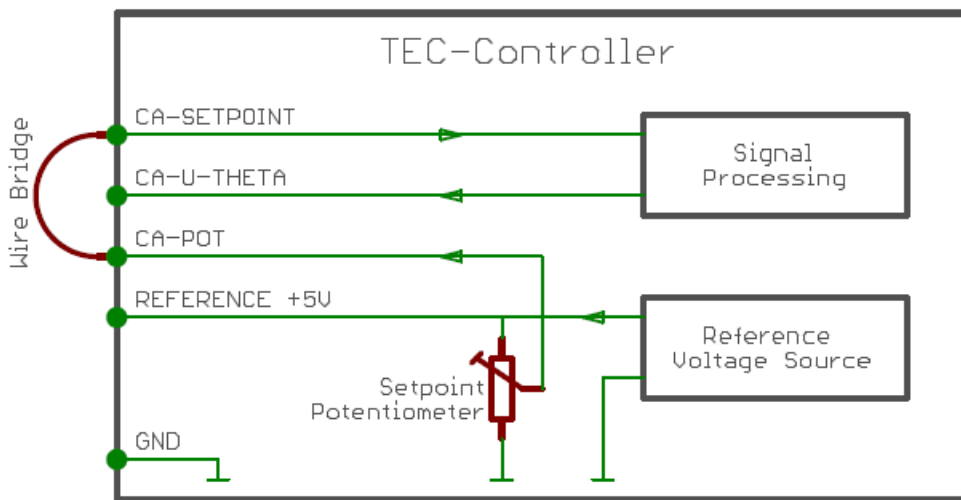

Fig. 22: Wiring of internal setpoint potentiometer

7.2.5.2. External Potentiometer with reference voltage

A simple way to control the HW-Setpoint from a remote position, is, to place a potentiometer (1k Ω , linear) in the setup. It is recommended to use a shielded cable. Make sure, the potentiometer is mounted electrically isolated.

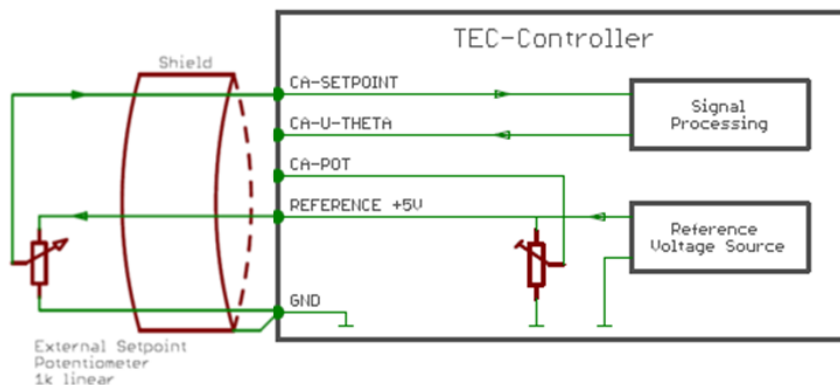



Fig. 23: Wiring of external setpoint potentiometer

MESSTEC Power Converter GmbH			
Operating Manual TEC-Controller 3A			
Document: 101001200M	Revision: 1.0	Date: 19.09.2022	Page 42/71

7.2.5.3. Voltage Controller

An external voltage controller (i.e. Digital to Analog Converter) can be provided as HW-Setpoint source. Wiring is according to Fig. 24.

Specification of the voltage controller:

- + Output voltage: 0 V ... 5 V
- + Output impedance: 1 k Ω max.
- + Output must be galvanically isolated

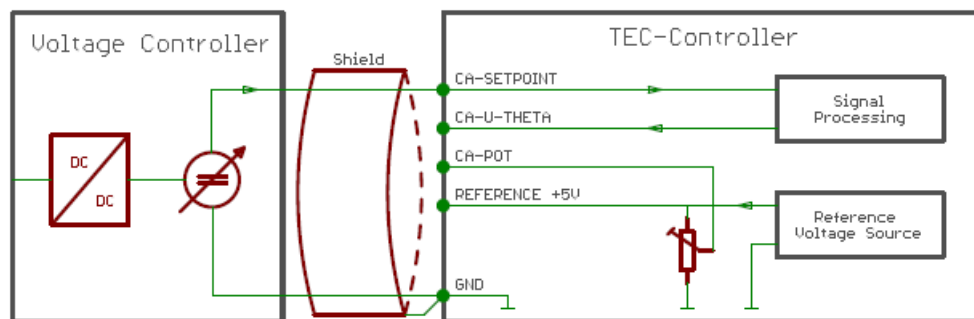



Fig. 24: Wiring external voltage controller

MESSTEC Power Converter GmbH			
Operating Manual TEC-Controller 3A			
Document: 101001200M	Revision: 1.0	Date: 19.09.2022	Page 43/71

7.2.6. Temperature Sensor X4

The temperature sensor must be assembled galvanically isolated. Make strictly sure that there is no electrical connection to any other potential.

Note: The temperature sensor interface is designed for RTD (Resistance Temperature Detector) sensors. Do not use integrated circuit or active temperature sensors in any case!

If the RTD sensor is polarized, the higher potential leads of the sensor are wired to the A-pins of the interface.

Note: A potential difference on the sensor inputs below 0,08 V (short circuit) or above 2,35 V (open circuit) will release a SENSOR Error.

Pin	Name	Function
1	TS-SUPP-A	Temperature Sensor Supply A
2	TS-SENS-A	Temperature Sensor Input A
3	TS-SENS-B	Temperature Sensor Input B
4	TS-SUPP-B	Temperature Sensor Supply B
5	GNDA	Analog Signal GND

TS-SUPP-A (X4-1)

Temperature Sensor Supply A
Current Source Contact A

Used for 4-wire and 2-wire sensor cabling.

TS-SENS-A – Input (X4-2)

Temperature Sensor Input A

Used for 4-wire sensor cabling.

TS-SENS-B – Input (X4-3)

Temperature Sensor Input B

Used for 4-wire sensor cabling.

TS-SUPP-B (X4-4)

Temperature Sensor Supply B
Current Source Contact B

Used for 4-wire and 2-wire sensor cabling.

GNDA – (X4-5)

Analog Signal GND

Shield of temperature sensor cabling (if required).

4-Wire Sensor cabling

For high precision temperature measurements it is recommended, to apply 4-wire cabling of the temperature sensor. In addition, a shielded cable may be appropriate in case of significant EMI (Electromagnetic Interference).

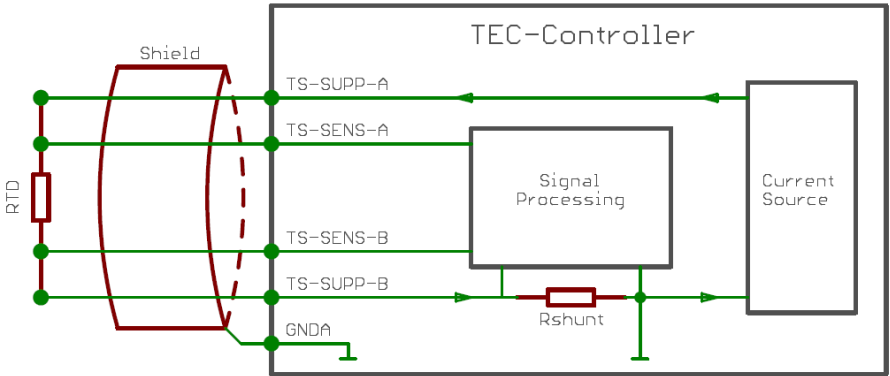

Fig. 25: Sensor cabling: 4-Wire

Note: Never mix up A and B pins. At the sensor end of the cable, signal TS-SUPP-A has to be combined only with TS-SENS-A. The same is true for the B signals of the interface.

2-Wire Sensor cabling

For temperature measurements with lower requirements, it may be adequate to apply 2-wire cabling of the temperature sensor. It is not necessary to externally short circuit the TS-SUPP and TS-SENS pins (A or B).

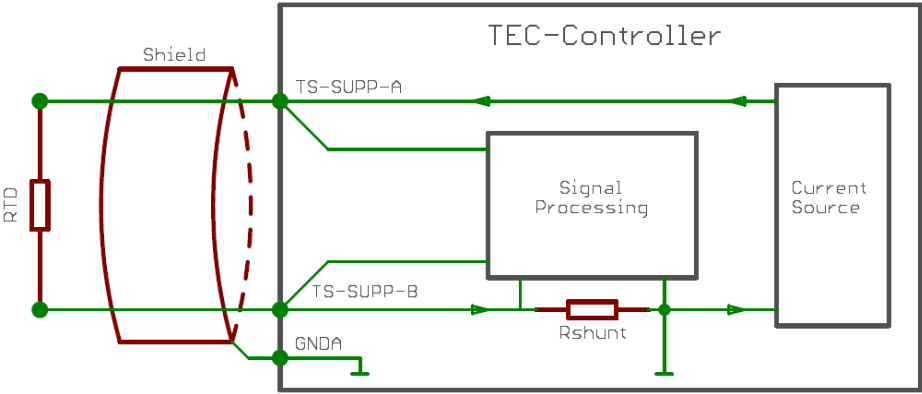



Fig. 26: Sensor cabling: 2-Wire

MESSTEC Power Converter GmbH			
Operating Manual TEC-Controller 3A			
Document: 101001200M	Revision: 1.0	Date: 19.09.2022	Page 45/71

7.2.7. USB/RS232

MPC TEC-Controllers are available in two different interface hardware versions. One version is equipped with USB interface (mainly for interconnection to a PC). The other version is equipped with RS232 interface (interconnection to a PC, an external controller, PLD or MCU).

USB interface:

The TEC-Controller has a built in USB 2.0 Mini-B connector.

For connection use standard USB cable:

- Mini-B male to Standard-A male (ordering code 10385120)
- Mini-B male to Type-C male (ordering code 11385247)

RS232 interface:

Serial port settings:

Baud rate: 38400
 Data length: 8 Bit
 Parity: none
 Stop: 1 Bit
 Flow control: none

Use RS232 interface cable (USB Mini-B to SubD9F, see Fig. 27) available from MPC (ordering code 10385263).

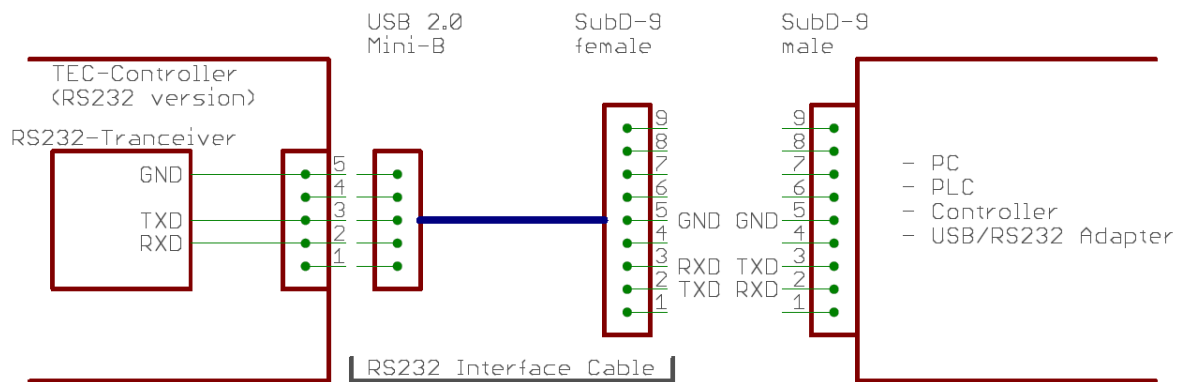



Fig. 27: RS232 interface cable

This interface cable can be connected directly to a RS232 port without using a Null-Modem cable.

Note: TEC-Controllers with RS232 interface are using the built in Mini-B connector as hardware connecting plug. In this case the MINI-B connector does not carry USB signals and should never be connected to the USB port of any PC. The USB port of the PC may be damaged.

MESSTEC Power Converter GmbH			
Operating Manual TEC-Controller 3A			
Document: 101001200M	Revision: 1.0	Date: 19.09.2022	Page 47/71

8. Configuration in Detail

8.1. HW Setpoint

The signal processing behavior of the input CA-SETPOINT can be configured in many ways to fit the best application setup. Following description applies to all possible wiring cases of this input (internal / external potentiometer, voltage source).

In any case, Fig. 28 shows the basic transfer function, with no minimum and maximum temperature set (default setting).

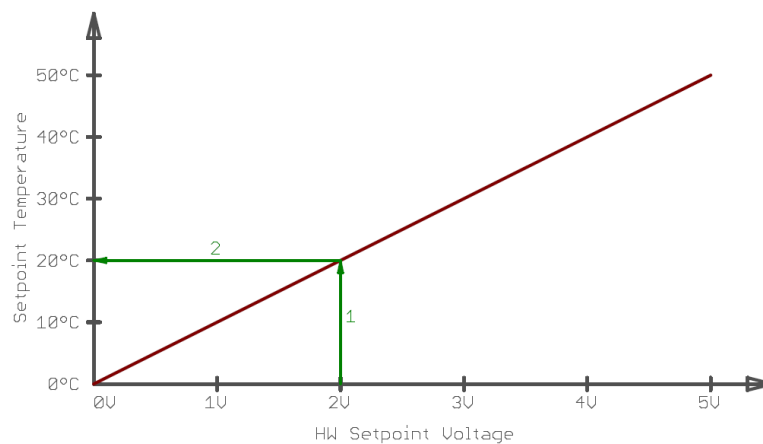

Fig. 28: Basic transfer function

The red curve shows the relationship between HW-Setpoint-Voltage (input voltage) and the temperature setpoint. With default settings (minimum temperature: 0 °C, maximum temperature: 50 °C) the relationship is linear.

Example: A voltage of 2 V at the input CA-SETPOINT will lead to a setpoint temperature of 20 °C (see green arrows 1 and 2).

Supplementary detailed information:

The relationship between the setpoint temperature and the HW-Setpoint-Voltage is:

$$\vartheta = U_{HW-SETPOINT} * 10 \frac{^{\circ}C}{V}$$

and accordingly:

$$U_{HW-SETPOINT} = \frac{\vartheta}{10 \frac{^{\circ}C}{V}}$$

By means of the PC-Software it is possible to set a maximum and a minimum temperature. Then it is necessary to distinguish between two different transfer modes:

- Clipping
- Slope Transformation

These modes are named "HW-Setpoint Boundary Mode" and can be set by PC-Software.

8.1.1. HW-Setpoint Boundary Mode: Clipping

In this mode, the relationship between the HW-Setpoint-Voltage and the temperature setpoint is not any longer linear for the whole range. Between min. and max. temperature the relationship is like in basic mode. Below min. and above max. temperature the transfer function is running horizontal (see solid red line in Fig. 29 below).

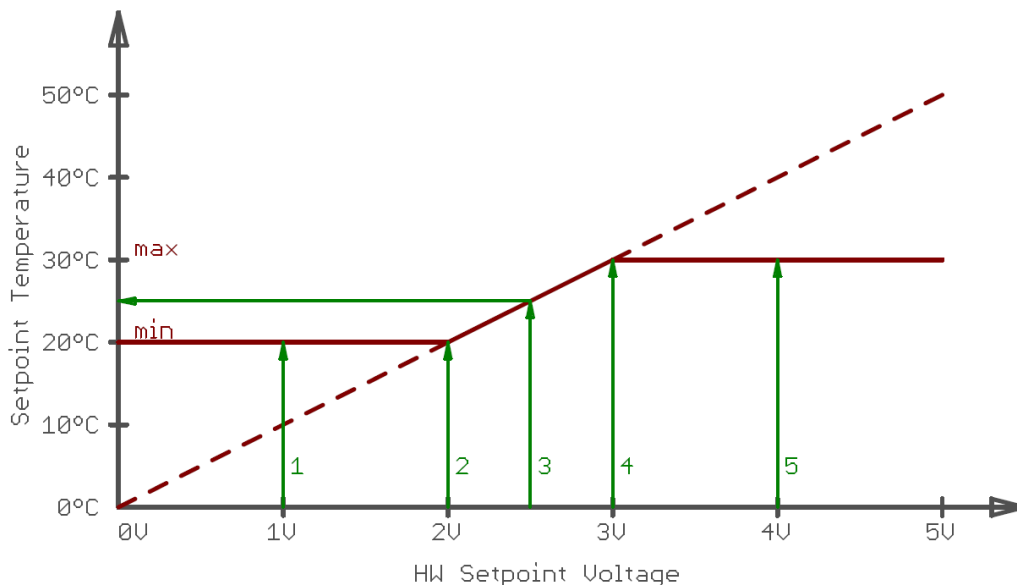



Fig. 29: Clipping mode transfer function

Example (see Fig. 29 above):

Supposed, min. temperature is set to 20 °C and max. temperature is set to 30 °C by PC-Software then a HW-Setpoint-Voltage between 2 V and 3 V leads to a temperature setpoint between 20 °C and 30 °C (arrows 2, 3 and 4). HW-Setpoint-Voltages below 2 V will lead to 20 °C (arrow 1) and HW-Setpoint-Voltages above 3 V will lead to 30 °C (arrow 5).

For purpose of illustration, the basic transfer function is also shown in Fig. 29 (dashed red line). It is apparent, that in between the two temperature limits, the transfer function is conform to the basic transfer function. Below and abo-

MESSTEC Power Converter GmbH			
Operating Manual TEC-Controller 3A			
Document: 101001200M	Revision: 1.0	Date: 19.09.2022	Page 49/71

ve these limits, the transfer function is clipped to min. temperature and max. temperature respectively.

Advantage: The relationship between input voltage and temperature setpoint in between the temperature limits is always the same. (see basic transfer function).

Disadvantage: The usable adjustment range (potentiometer or voltage source) may get too tiny for practical purpose.

8.1.2. HW-Setpoint Boundary Mode: Slope Transformation

In this mode, the relationship between the HW-Setpoint-Voltage and the temperature setpoint is still linear but has a different slope than the basic transfer function. Now a HW-Setpoint-Voltage of 0 V leads to a setpoint of min. temperature and 5 V lead to a setpoint of max. temperature (see solid red line in Fig. 30 below). This means, the complete input voltage range is used.

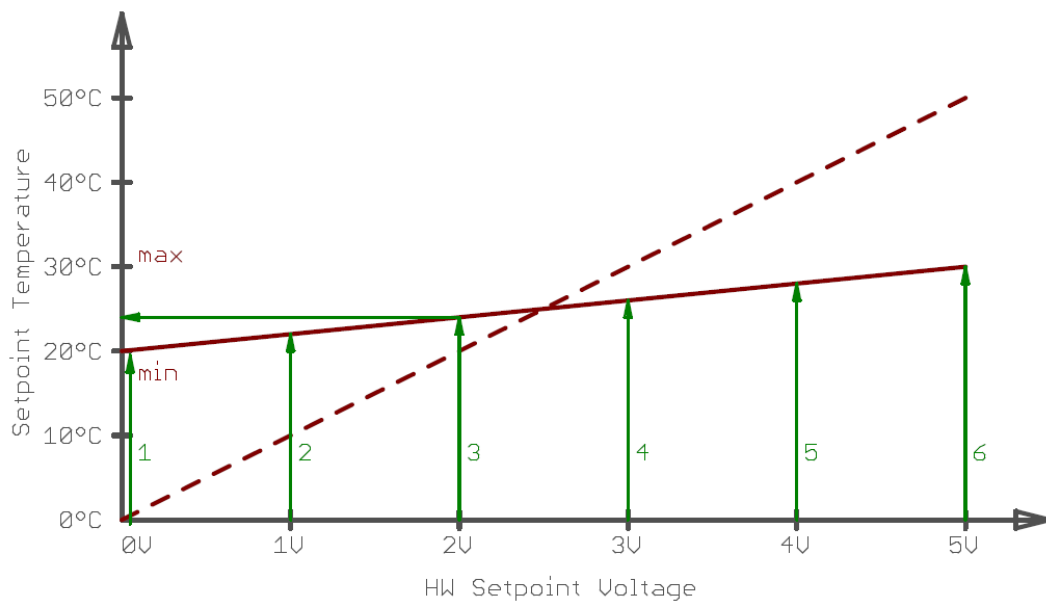



Fig. 30: Slope transformation mode transfer function

Example (see Fig. 30 above):

Supposed, min. temperature is set to 20 °C and max. temperature is set to 30 °C by PC-Software then a HW-Setpoint-Voltage between 0 V and 5 V leads to a temperature setpoint between 20 °C and 30 °C (arrow 1 to 6).

I.E. a voltage of 2,0 V results in a temperature setpoint of 24 °C (arrow 3).

MESSTEC Power Converter GmbH			
Operating Manual TEC-Controller 3A			
Document: 101001200M	Revision: 1.0	Date: 19.09.2022	Page 50/71

Supplementary detailed information:

The relationship between the setpoint temperature and the HW-Setpoint-Voltage is:

$$\vartheta = \left\{ \frac{\vartheta_{MAX} - \vartheta_{MIN}}{5,0} * U_{HW-SETPOINT} \right\} + \vartheta_{MIN}$$

and accordingly:

$$U_{HW-SETPOINT} = \frac{5,0}{\vartheta_{MAX} - \vartheta_{MIN}} * \{\vartheta - \vartheta_{MIN}\}$$

For purpose of illustration, the basic transfer function is also shown in Fig. 30 (dashed red line). It is apparent, that the slope of the transfer function has changed, it is transformed to the actual min. and max. temperature values.

Advantage: The usable adjustment range (potentiometer or voltage source) is always the full range (0 V to 5 V).

Disadvantage: The relationship between input voltage and temperature setpoint is dependent on min. and max temperature settings.

MESSTEC Power Converter GmbH			
Operating Manual TEC-Controller 3A			
Document: 101001200M	Revision: 1.0	Date: 19.09.2022	Page 51/71

8.2. Digital Inputs and Outputs

The entire configuration of digital inputs and outputs can be carried out by PC-Software. There is no need, to modify the hardware.

8.2.1. Inputs

Digital inputs are compatible to TTL and can be configured as

- LOW active
- HIGH active

The default setting is LOW active.

Supplementary detailed information:

A pullup or pulldown resistor (10 kΩ) will be internally connected accordingly (see Fig. 31 below).

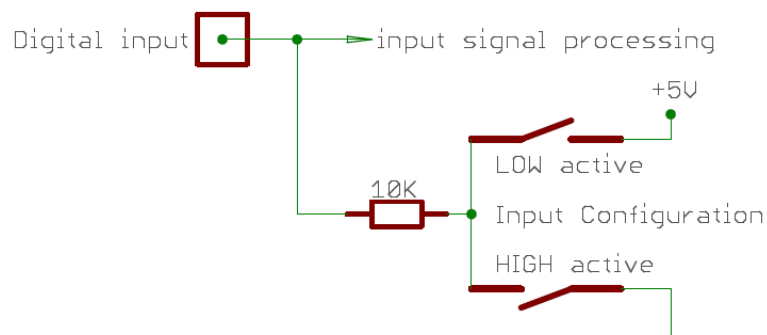

Fig. 31: Digital input circuit

8.2.2. Outputs

Digital outputs are compatible to TTL and can be configured as

- LOW active
- HIGH active

The default setting is HIGH active.

Furthermore the output stage can be configured as

- Totem Pole (push-pull)
- Open Collector

The default setting is Totem Pole.

When set to Totem Pole, the output resistance is 330Ω.

When set to Open Collector, the output resistance is very low (0,5 Ω). In this case the output can sink up to 500 mA and is short circuit protected.

Note: Also in Open Collector configuration, the output voltage coming from the external circuit, must not exceed 5 V.

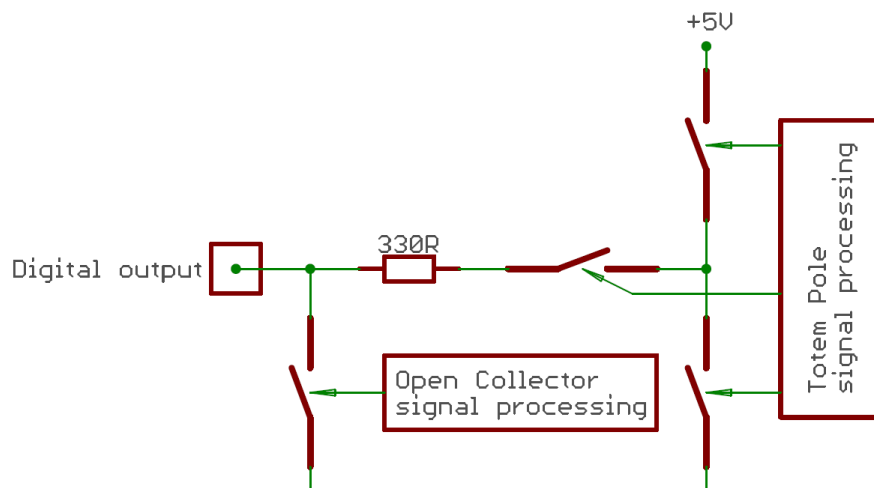



Fig. 32: Digital output circuit

MESSTEC Power Converter GmbH			
Operating Manual TEC-Controller 3A			
Document: 101001200M	Revision: 1.0	Date: 19.09.2022	Page 53/71

9. Error states

There are 3 different error states:

- Sensor Error
- Overtemperature Error
- Shortcircuit Error

If an error occurs, the TEC-Controller goes into the corresponding error state immediately. This means that:

- the TEC-Controller is disabled.
- the output stage is set to zero immediately. Output current is zero.
- the control signal output READY is set inactive.
- the ERROR LED will flash accordingly.
- it is no longer possible, to enable the TEC-Controller.

The ERROR LED is flashing periodically:

- 1 short flash: SENSOR Error
- 2 short flashes: SHORTCIRCUIT Error
- 3 short flashes: OVERTEMPERATURE Error

To clear an error, do follow the indicated procedure:

- disable HW-ENABLE input
- troubleshoot the cause of the error
- activate HW-RESET input (error state is cleared)

Now, the TEC-Controller is ready for normal operation again.

It is also possible to clear an error by clicking the Reset button in the PC-Software.

9.1. SENSOR Error

When the incoming signal from the temperature sensor is outside the normal working range of the temperature sensor input, a SENSOR Error is released. The cause may be

- sensor is broken or cabling is poor
- sensor is short circuit or cabling is poor
- in the PC-Software the arbitrary sensor or sensor current is specified inadequately

MESSTEC Power Converter GmbH			
Operating Manual TEC-Controller 3A			
Document: 101001200M	Revision: 1.0	Date: 19.09.2022	Page 54/71

9.2. OVERTEMPERATURE Error

When the temperature of the power semiconductors exceeds 80 °C, an OVERTEMPERATUR Error is released.

When the temperature is below 75 °C again, this error can be cleared by Reset signal

Ensure sufficient cooling if necessary.

9.3. SHORTCIRCUIT Error

When the output current of the power stage exceeds a certain level, a SHORTCIRCUIT Error is released. The short circuit detector is implemented in hardware and therefore reacting fast (no software latency). In this way, the output stage is protected from damage. Under normal operating conditions this current level is out of reach.

MESSTEC Power Converter GmbH			
Operating Manual TEC-Controller 3A			
Document: 101001200M	Revision: 1.0	Date: 19.09.2022	Page 55/71

10. PC Software: TEC Control

TEC Control Software

- is a software package which will run on any PC.
- is compatible with all TEC-Controllers from MPC.
- is operated only using the mouse.

With the TEC Control Software it is possible to

- configure
- control
- monitor

MPC TEC-Controllers extensively.

TEC Control Software is separately available (Ordering Code 31000055).

10.1. Main menu

To start the program, double click the MPCTEC icon.

If there is available more than one COM-Port on your PC, during startup you will be asked to select the COM-Port, where the TEC-Controller is connected to.

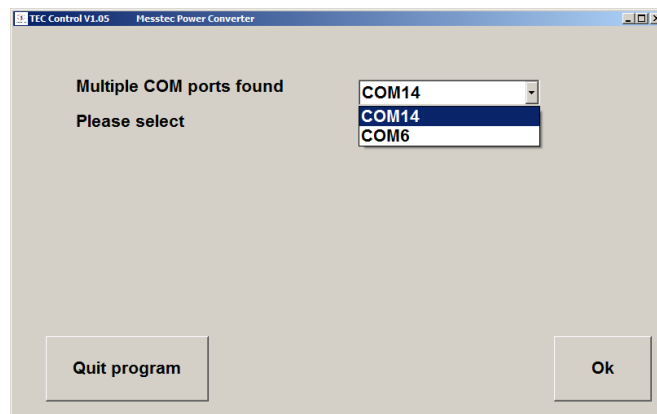

Fig. 33: Select COM-Port

After having built up the communication, the main menu will be displayed.

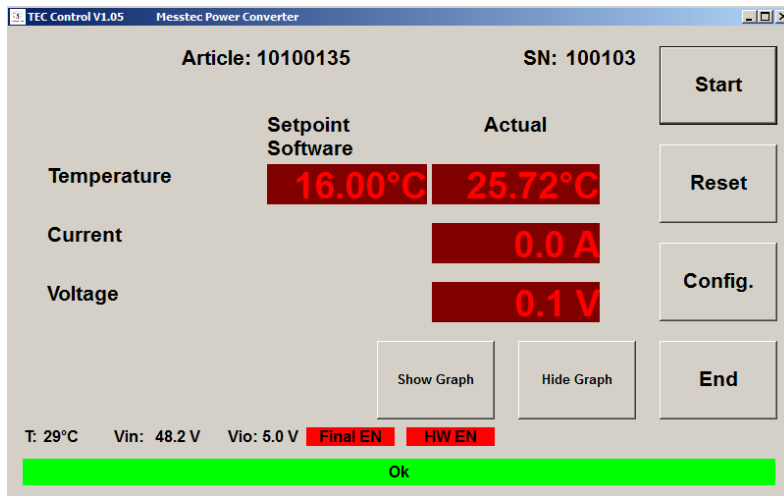
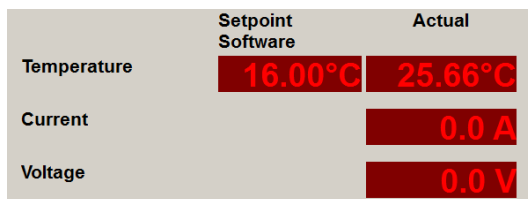

Fig. 34: Main menu

In the upper part of the main menu some general information are given:

- software version (of the PC software)
- article number (of the interconnected TEC-Controller)
- serial number (of the interconnected TEC-Controller)



In the middle region of the menu there is displayed:

- actual sensor temperature
- actual output current
- actual output voltage

The temperature setpoint is displayed on the left side.

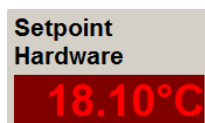

If setpoint mode is set to hardware (see configuration), this value is set by the analog voltage at the input HW-SETPOINT.

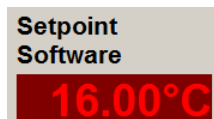

If setpoint mode is set to software, a single mouse click into the display opens a menu, where you can set the temperature setpoint. Just click on the up and down arrows accordingly. Click on the OK button to accept the value.

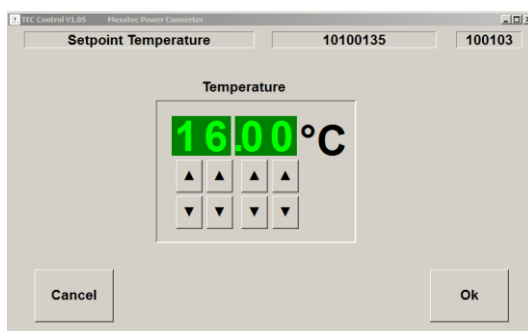

MESSTEC Power Converter GmbH			
Operating Manual TEC-Controller 3A			
Document: 101001200M	Revision: 1.0	Date: 19.09.2022	Page 57/71

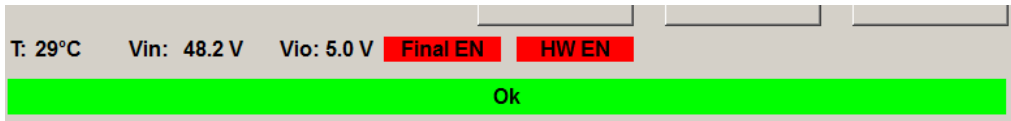

In the lower part of the main menu, some monitoring values are being displayed:

- T Temperature of the power stage or mounting plate
- Vin Level of the power supply voltage
- Vio Level of the reference voltage output (X1-4)

Final EN: **Final EN** : Final Enable is disabled
 Final EN : Final Enable is enabled

HW EN: **HW EN** : Hardware Enable is disabled
 HW EN : Hardware Enable is enabled

The behavior of the internal safety signal Final EN is dependent on the ENABLE MODE and the input signal HW ENABLE (see chapter "Control Signals Digital X2" and "Configuration").

HW EN is reflecting the state of the input signal HW ENABLE.

The status bar at the bottom shows the general condition of the TEC-Controller:

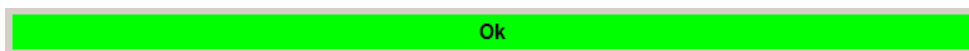

TEC-Controller is working fine, there are no errors.
If the TEC-Controller is enabled, then Ok means, the sensor temperature is within +/- 1°C of the setpoint.

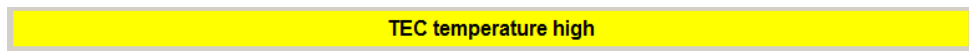

or

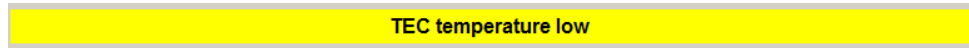

TEC-Controller is enabled and sensor temperature is outside +/- 1°C of the temperature setpoint.



Errors are marked in red. See also chapter Error states.



USB connection does not work properly. Double check cabling of serial interface or COM-port setting and restart program.



With the Start button the TEC-Controller is enabled, when enable mode is set to software. When set to hardware, the Start button is greyed out (see right).

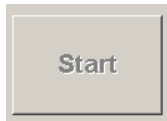

With the Reset button, error states can be reset (see Error states).

Note: This is not a Reset button for the MCU.

Config. button opens the Configuration menu (see Configuration).

Note: The Config. button is only active, when the TEC-Controller is disabled.

End button quits the PC-Software.

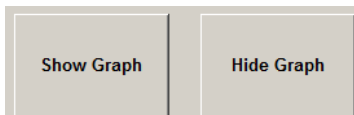

It is possible, to show the temperature profile in a graphic chart. With Show Graph and Hide Graph the chart is opened or closed, respectively. Axes are scaled automatically.

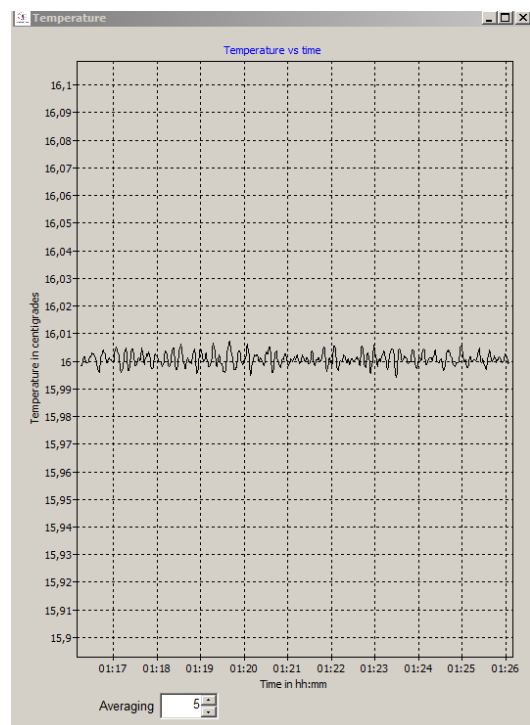
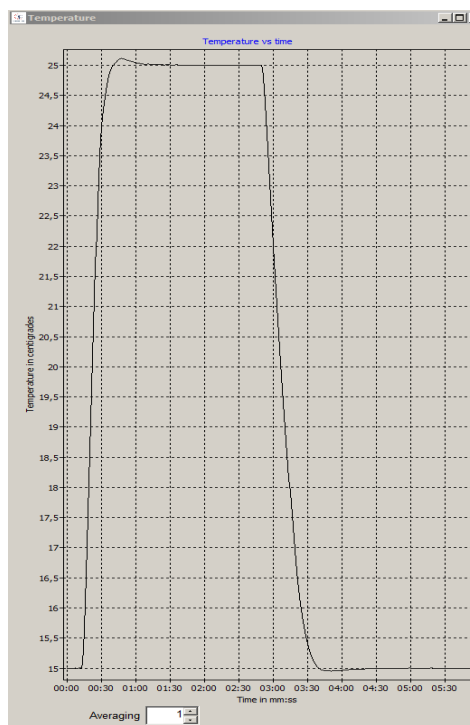

On the bottom of the Graph it is possible to choose an averaging factor. Default setting is 5.

The size of the graph window can be set by clicking on one of the corners with the left mouse button, and holding the mouse button. Move the corner to set desired size.

10.2. Configuration

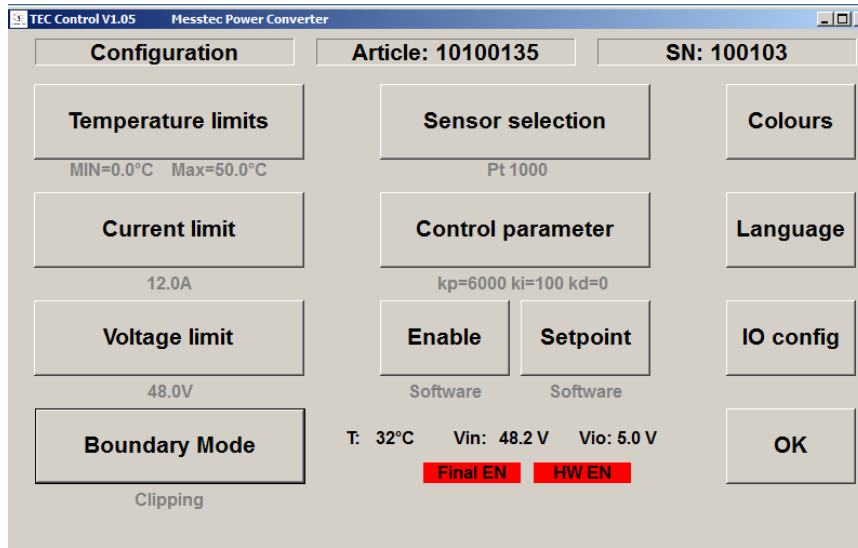
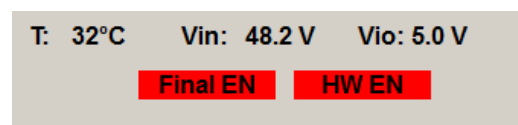

Fig. 35: Configuration

Note: It is possible to enter the configuration menu, only if the TEC-Controller is disabled.

Below the buttons, the selected and active configuration is displayed.

In most menus the desired value is set by clicking the up or down arrow buttons accordingly.



In the lower part of the configuration menu, the same monitoring values are being displayed as in the main menu (see section Main menu).

MESSTEC Power Converter GmbH			
Operating Manual TEC-Controller 3A			
Document: 101001200M	Revision: 1.0	Date: 19.09.2022	Page 60/71

10.2.1. Temperature limits

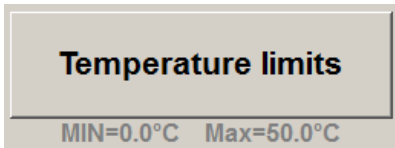

Click this button to open the next menu. Here it is possible to set temperature limits.

Note: MIN Temperature must be at least 1 °C below MAX Temperature. Only then it is possible to confirm with Ok.

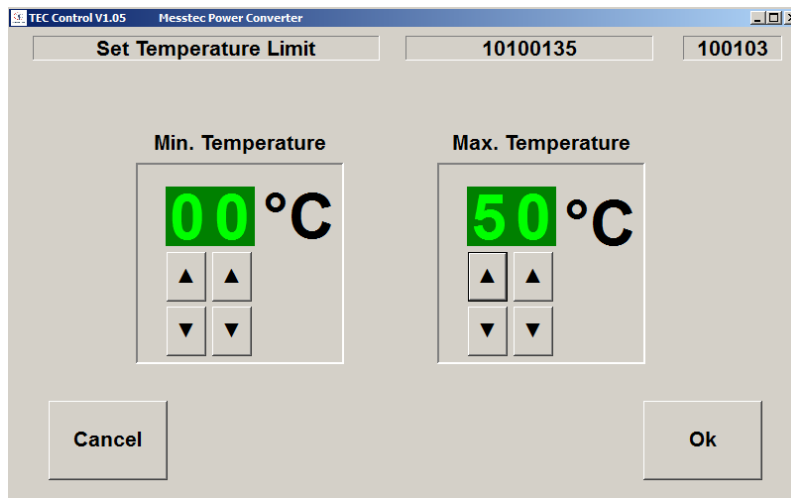

10.2.2. Current limit

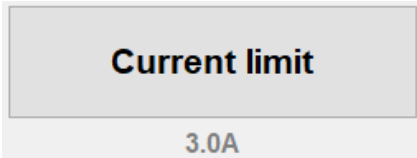

Click this button to open the next menu. Here it is possible to set the maximum output current.

Note: Lowest setting is 1 A. Highest setting is 3 A.

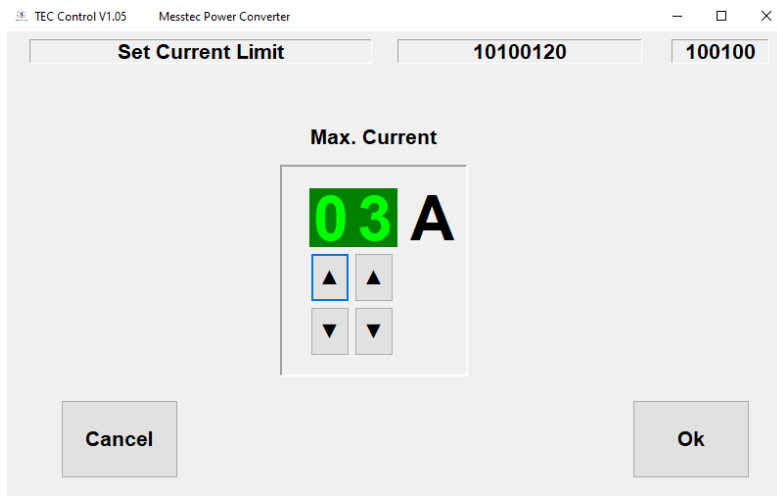

10.2.3. Voltage limit

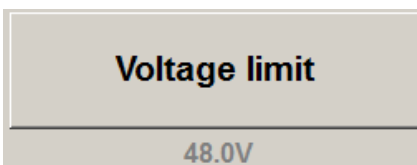

Click this button to open the next menu. Here it is possible to set the maximum output voltage.

Note: Lowest setting is 1 V. Highest setting is 48 V.

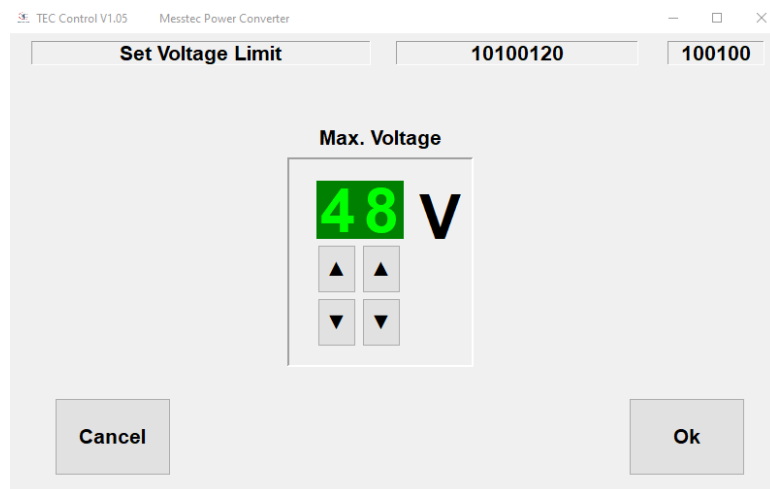

10.2.4. Boundary Mode

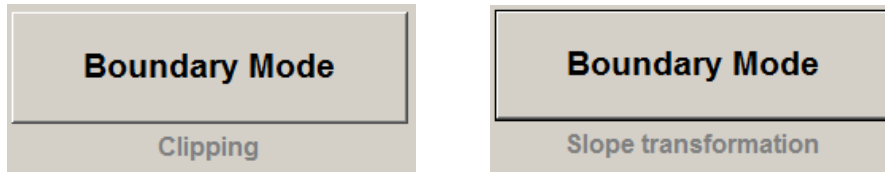

Click this button, to change the setting of the HW-Setpoint Boundary Mode.

See also: Configuration in Detail / HW Setpoint.

10.2.5. Sensor selection

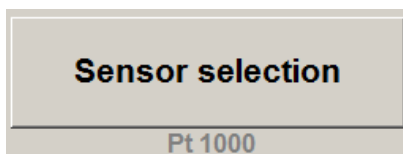

Click this button to open the next menu. Here it is possible to select the temperature sensor in use.

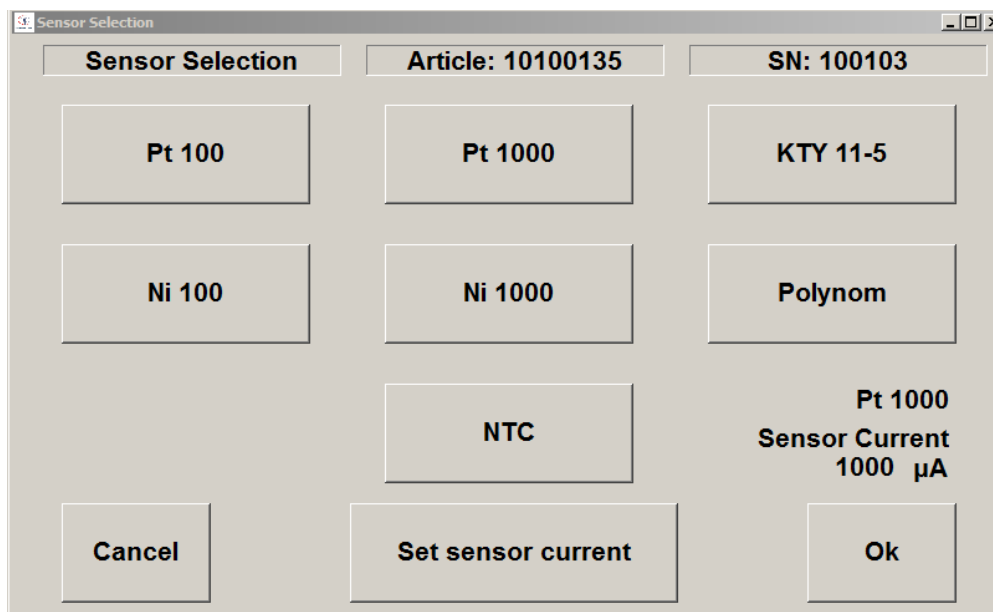

See also section "Temperature sensor".

10.2.6. Control parameter



Click this button to open the next menu. Here it is possible to adjust the control parameters.

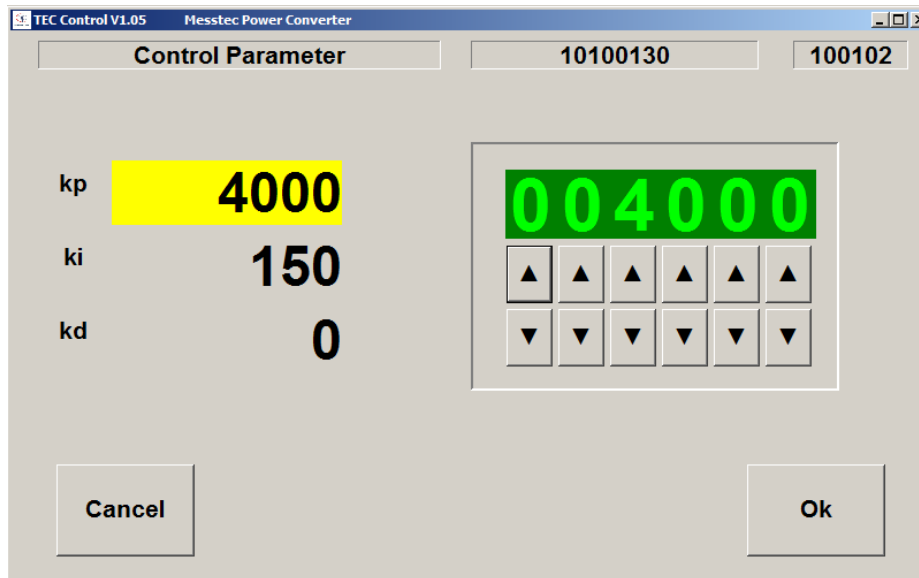

- kp: Coefficient of the proportional component of the control loop
- ki: Coefficient of the integral component of the control loop
- kd: Coefficient of the derivative component of the control loop

Note: kd is used only in very rare and exceptional cases.

In most cases it is not necessary to alter control coefficients. If you do need to make adjustments to control coefficients, consider small steps and double check the result after each step.

Note: Modifications of control coefficients in the wrong direction will quickly result in total malfunction and instability of the control loop. This may further damage your system setup.

10.2.7. Enable Mode

Click this button to change the enable mode between hardware and software. That is the way, the TEC-Controller can be activated.

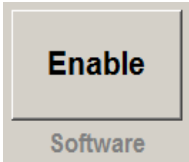

Hardware: The input signal HW Enable activates the TEC-Controller.
Software: The Start button in the main menu and the input signal HW enable in combination, activates the TEC-Controller.

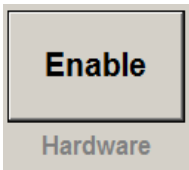

See also section **Control Signals Digital X2**.

Note: Enable mode can only be changed (Enable button is active), when the input signal HW Enable is disabled.

Note: When enable mode is set to hardware, the Start button in the main menu is not active.

10.2.8. Setpoint Mode

Click this button to change the setpoint mode between hardware and software. That is the way, the desired temperature is determined and entered into the TEC-Controller.



Hardware: An analog voltage, which is proportional to the setpoint temperature, is applied to the HW SETPOINT input.
Software: The setpoint temperature is selected in the main menu.





See also section **Control Signals Analog X1**.

Note: The HW SETPOINT input is highly configurable. See section Configuration in Detail / HW Setpoint.

10.2.9. Colours

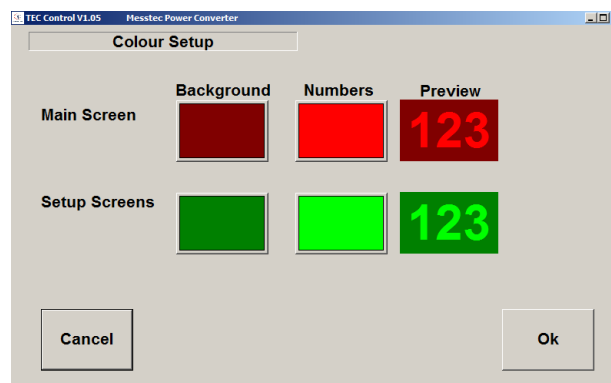
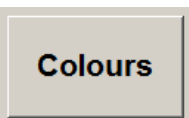
Click this button to open the next menu. Colours can be customized as desired.



MESSTEC Power Converter GmbH			
Operating Manual TEC-Controller 3A			
Document: 101001200M	Revision: 1.0	Date: 19.09.2022	Page 65/71

10.2.10. Language

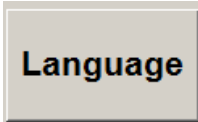

Click this button to open the next menu. Select language as desired.

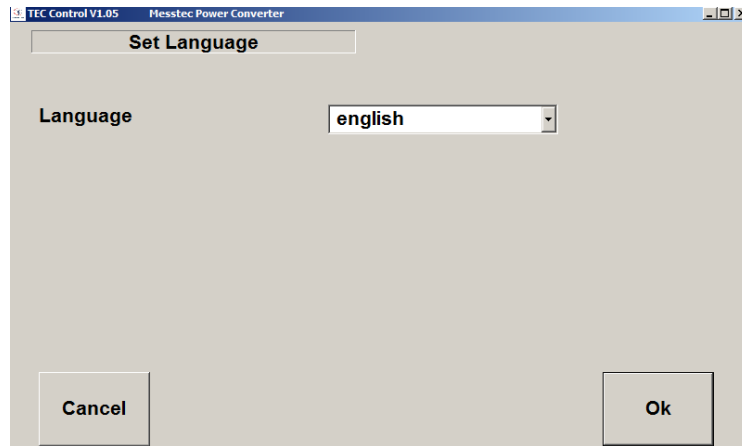

10.2.11. IO Configuration

It is possible to change and customize the configuration of digital inputs and digital outputs in a substantial way.

Digital inputs:

- LOW active
- HIGH active

Digital outputs:

- LOW active
- HIGH active
- Totem pole (push-pull)
- Open collector

See also section Configuration in Detail / Digital inputs and Outputs.

Example: Changing the input CD-ENABLE from active LOW to active HIGH.

Configurations in this domain generally have big influence to the control behavior of the TEC-Controller and its setup. To avoid damage and malfunction in any case, the TEC-Controller goes into a Safe-State, which only can be left by switching off the power supply of the TEC-Controller. Then it is possible to adjust the setup (wiring, control logic etc.) safely.

MESSTEC Power Converter GmbH			
Operating Manual TEC-Controller 3A			
Document: 101001200M	Revision: 1.0	Date: 19.09.2022	Page 66/71



Click this button to open the next menu.

At first a warning message will appear. Once you are certain, you know what you are doing, click the continue button.

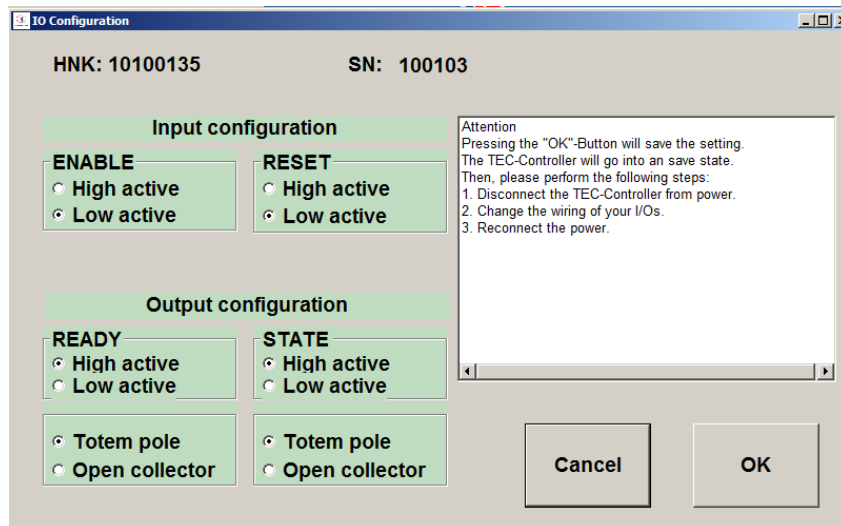
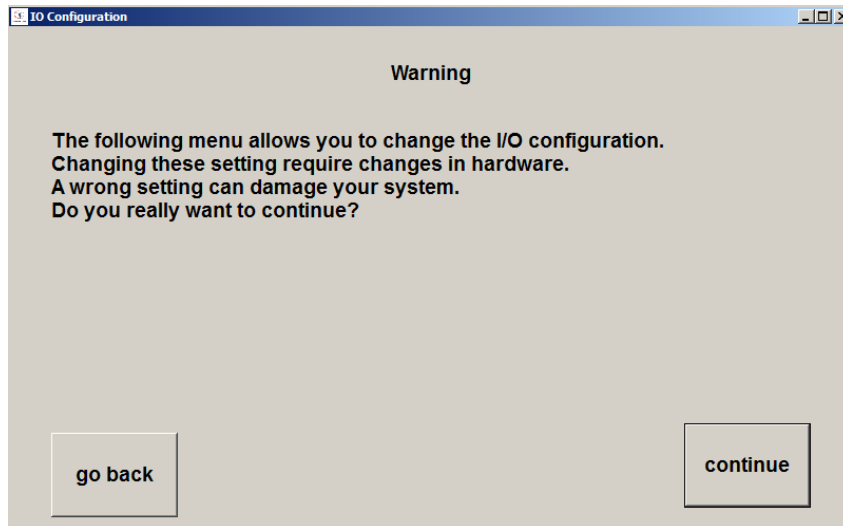

Now you can select the configuration of digital inputs and digital outputs as desired.

Please follow the advice, displayed in the window. After pressing the OK button, the TEC-Controller will go into a save state. This is normal procedure, a safety measure and NOT an error state.

MESSTEC Power Converter GmbH			
Operating Manual TEC-Controller 3A			
Document: 101001200M	Revision: 1.0	Date: 19.09.2022	Page 67/71

A final note will be displayed.

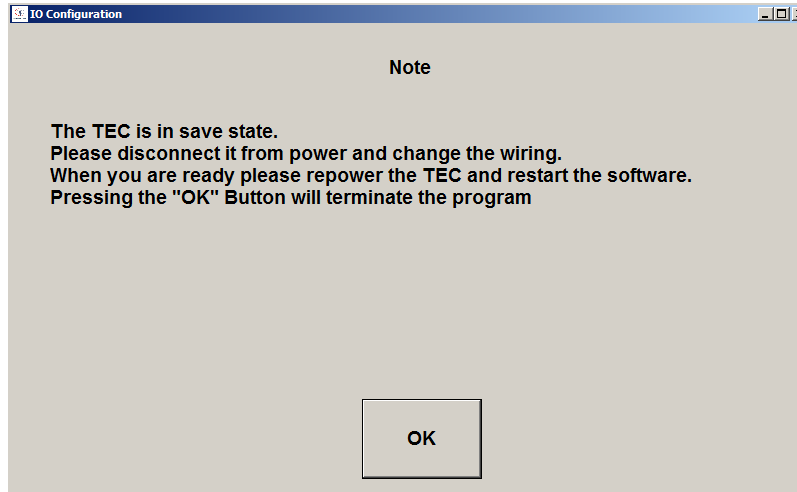

After clicking the OK button, the PC Software will be terminated automatically.

Next, disconnect the TEC-Controller from the power supply.

Change the wiring and control logic configuration of your setup according to the just altered IO configuration of the TEC-Controller.

Switch on the power supply of the TEC-Controller again. Start the PC-Software again.

Now the setup and the TEC-Controller is operating with the new IO configuration.

MESSTEC Power Converter GmbH			
Operating Manual TEC-Controller 3A			
Document: 101001200M	Revision: 1.0	Date: 19.09.2022	Page 68/71

10.3. USB Driver

When the TEC-Controller (USB version) is connected to the PC for the first time, the correct USB driver will be installed automatically.

In any case, the correct USB driver is located on the CD-ROM.

11. Drawings

11.1. Mechanical Drawings

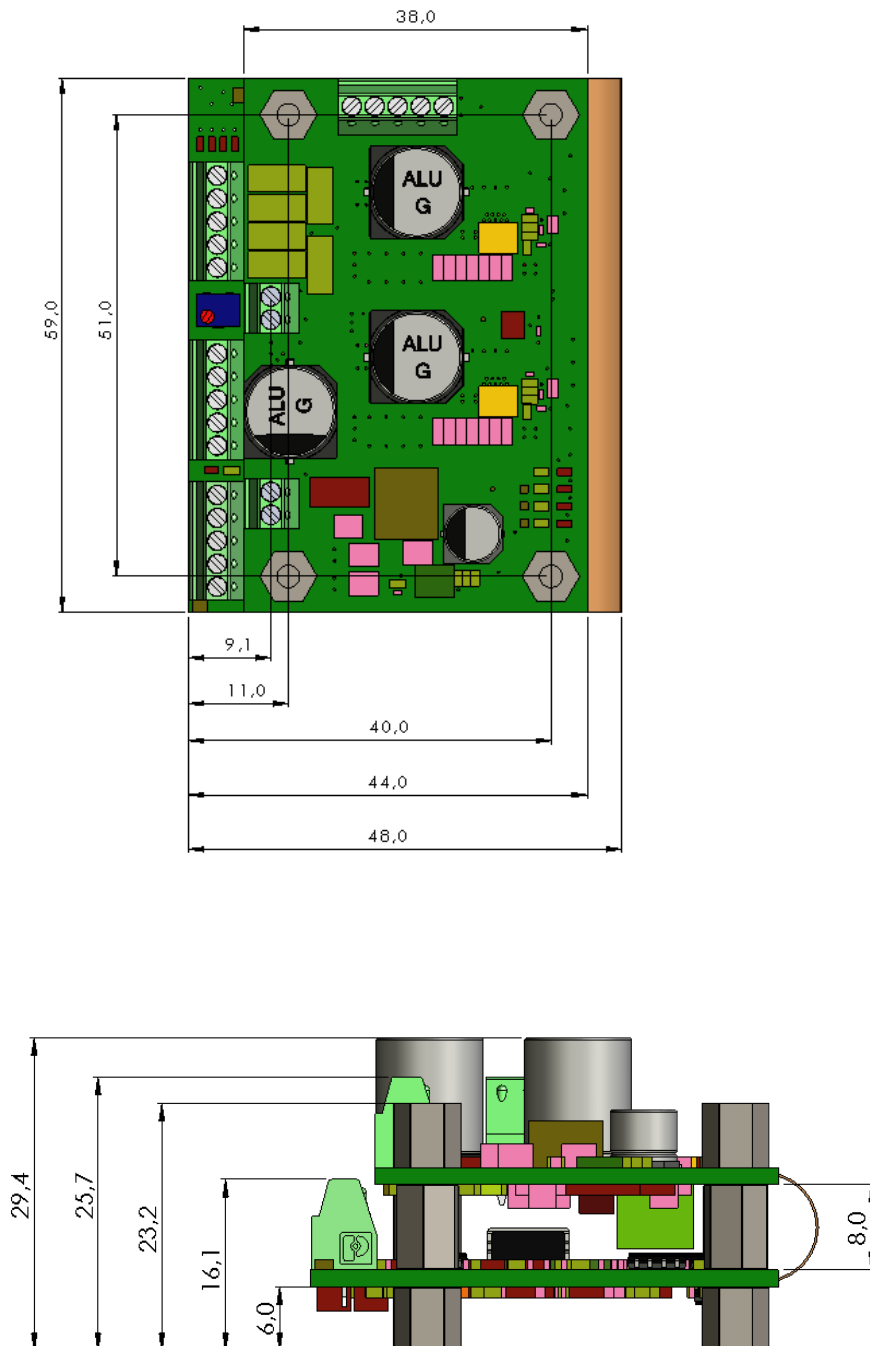

11.2. **Mounting Positions**

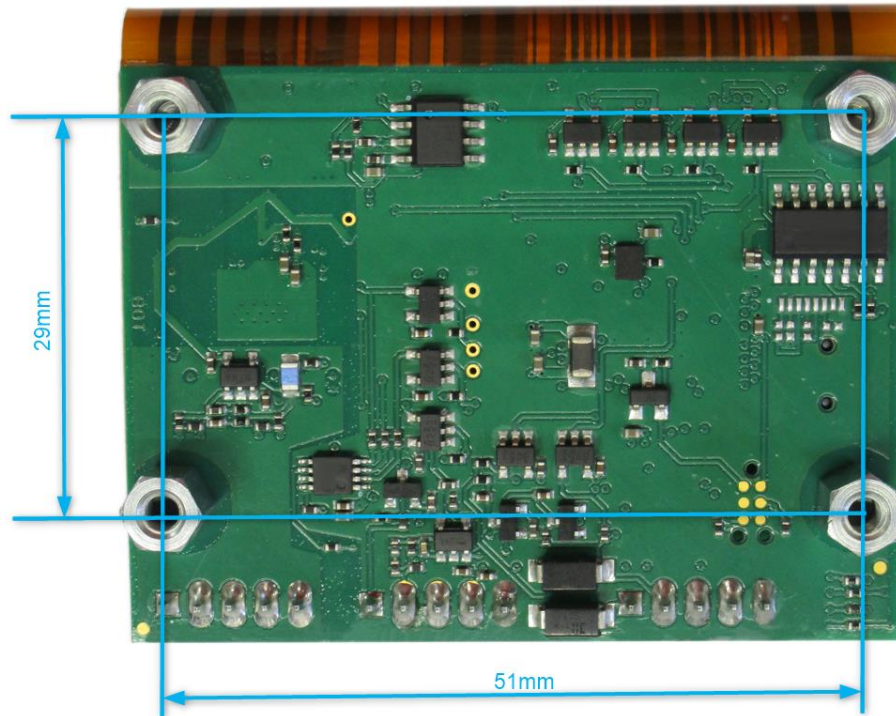

Bottom view

MESSTEC Power Converter GmbH			
Operating Manual TEC-Controller 3A			
Document: 101001200M	Revision: 1.0	Date: 19.09.2022	Page 71/71

12. TEC-Controller family

Type	Description	Ordering code
TEC 3-50-U	TEC 3A with USB interface	10100120
TEC 3-50-R	TEC 3A with RS232 interface	10100121
RS232 interface cable	USB Mini-B to SubD9F adapter cable	10385263
USB cable	Mini-B to Standard-A cable	10385120
USB cable	Mini-B to Type-C cable	11385247
TEC Software	Control-Software for PC	31000055
Temperature Sensor	Pt1000 (without cable)	10805048

Contact Data

MESSTEC Power Converter GmbH
 Grube 41
 D-82377 Penzberg
 Phone +49 (0) 8856-80306-0
info@powerconverter.com
www.powerconverter.com

Technical subjects to change without notice.